

# INSTRUKCJA MONTAŻU

FITTING-UP INSTRUCTION / AUFBAUANLEITUNG

MONTÁŽNÍ NÁVOD / MONTÁŽNY NÁVOD / SZERELÉSI UTASÍTÁS

**restol**®

Producent:

**Restol sp. z o.o.**

36-055 BRATKOWICE

www.restol.com.pl

# Theo THW-2P

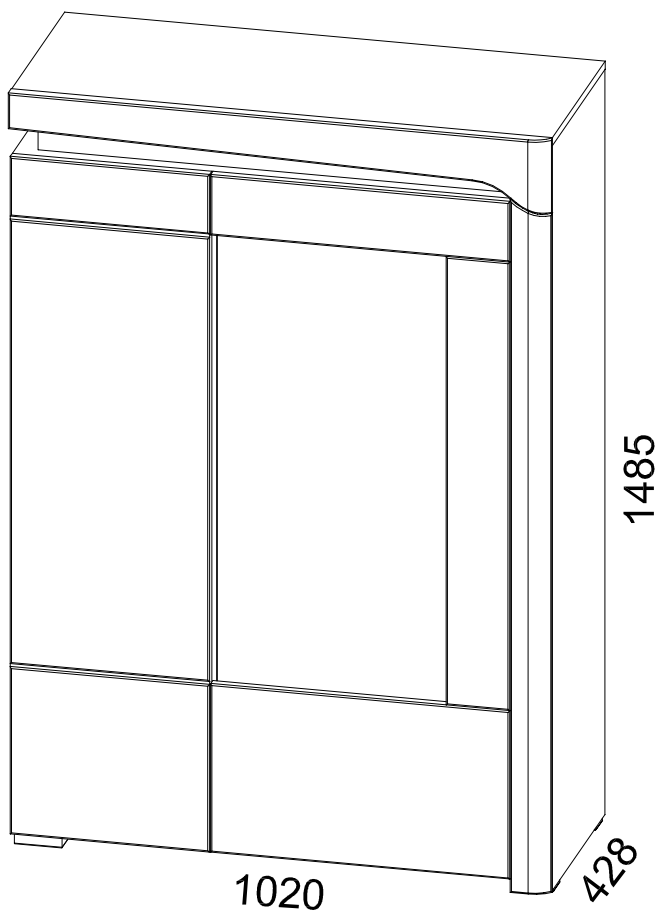

1020 x 1485 x 428 /mm/

#### **WSKAZÓWKA na temat pielęgnacji mebla.**

Czyścić elementy wilgotną szmatką lub papierowym ręcznikiem.  
Nie używać chemicznych środków czyszczących.

#### **DIRECTION for the furniture cleaning.**

Clean elements with the moist wiper or soft paper towel. Do not use any detergents.

#### **Pflegehinweis.**

Nur mit feuchtem Lappen, bzw. Papiertuch Ihre Möbel reinigen.  
Keine chemischen Waschmittel einsetzen.

#### **POKYN pro ošetřování nábytku!**

Díly čistit vlhkým hadříkem nebo papírovou utěrkou.  
Nepoužívat chemické čističí prostředky.

#### **POKYNY k údržbě nábytku.**

Prvky nábytku čistit vlhkou handričkou alebo papierovou utierkou  
Nepoužívať chemické čistiace prostriedky.

#### **UTMATATÓ a bútor ápolására.**

Az elemeket nedves ronggyal vagy papírtörülközővel tisztítani.  
Vegyi tisztítószert nem használni.

Gwarancja dostępna pod linkiem:

Guarantee available at:

Die Garantie ist unter dem Link:

Záruka je k dispozici na následujícím odkazu:

Záruka k dispozícii pod odkazom:

Link a jótálláshoz :

[www.sklep.restol.com.pl/  
upload/gwarancja.pdf](http://www.sklep.restol.com.pl/upload/gwarancja.pdf)

NR	WYMIARY	SZT	PACZKA
2	987 x 400 x 16	1	1 / 3
5	1294 x 400 x 16	1	2 / 3
6	616 x 384 x 16	1	1 / 3
8	343 x 115 x 16	2	2 / 3
9	963 x 115 x 16	1	2 / 3
10	1294 x 616 x 16	1	3 / 3
11	355 x 375 x 16	3	1 / 3
12	1322 x 384 x 3	1	2 / 3
13	614 x 360 x 6	2	1 / 3
14	444 x 909 x 4	1	3 / 3
16	1329 x 376 x 18	1	3 / 3
18	52 x 400 x 16	1	2 / 3
19	1020 x 147,2 x 22	1	2 / 3
20	1360,5 x 74 x 22	1	3 / 3
21	564 x 120 x 18	1	3 / 3
22	878 x 120 x 18	1	3 / 3
23	331 x 564 x 18	1	3 / 3
51	1019 x 400 x 16	1	1 / 3
53	1462 x 400 x 16	1	2 / 3
54	1310 x 400 x 16	1	2 / 3
57	1004 x 400 x 16	1	1 / 3

## INSTRUKCJA MONTAŻU

FITTING-UP INSTRUCTION / AUFBAUANLEITUNG  
MONTÁŽNÍ NÁVOD / MONTÁŽNY NÁVOD / SZERELÉSI UTASÍTÁS

Do montażu potrzebne są:  
You need for fitting-up:  
Zur Montage werden Sie brauchen:  
K montáži jsou potřebné:  
Na montáž potrebujete:  
A szereléshez szükséges:

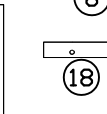
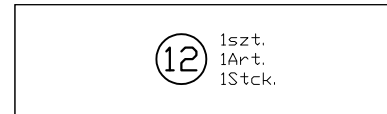
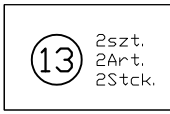
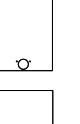
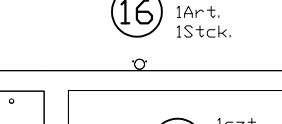
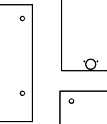
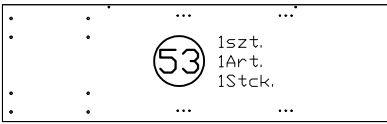
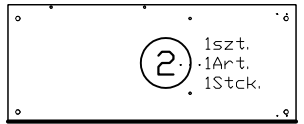
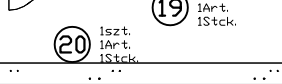
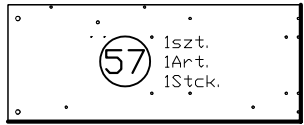
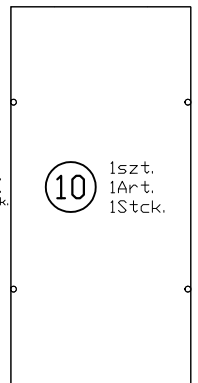
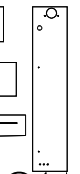
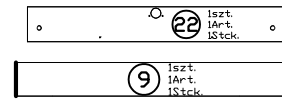
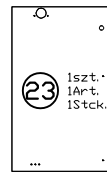
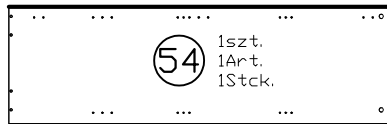
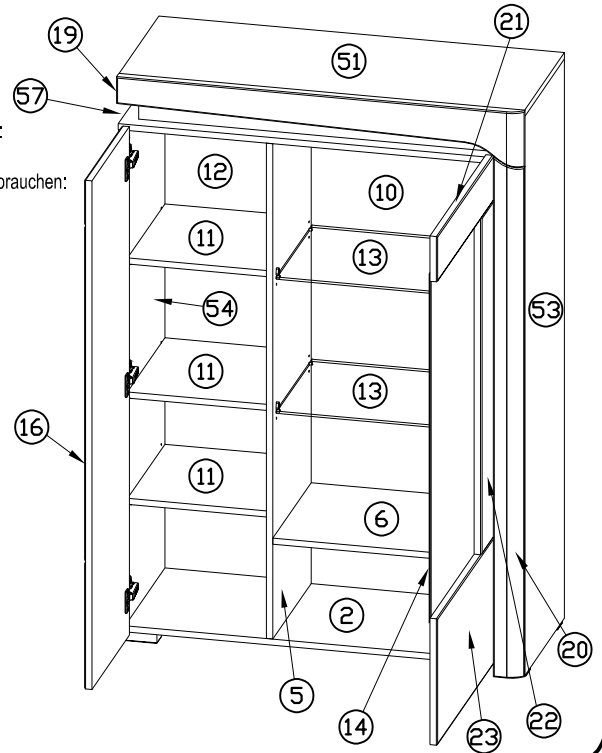
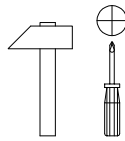
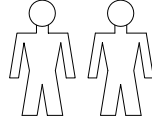

**restol**®

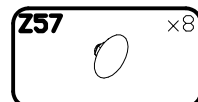
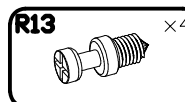
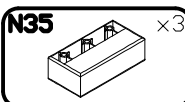
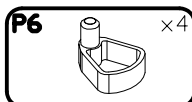
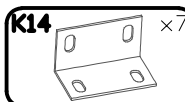
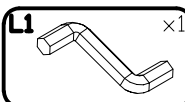
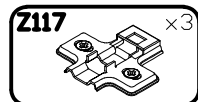
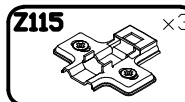
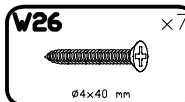
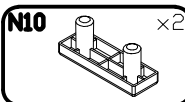
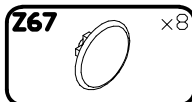
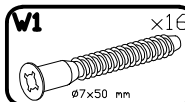
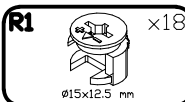
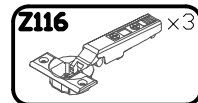
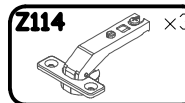
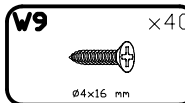
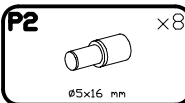
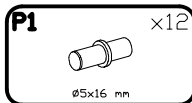
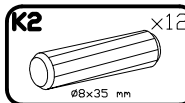
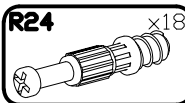
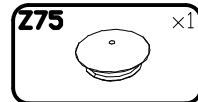
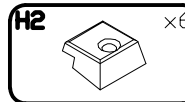
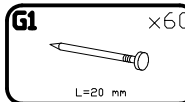
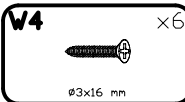
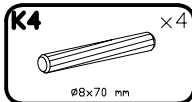
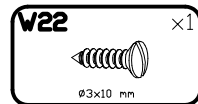
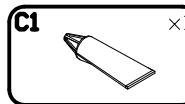
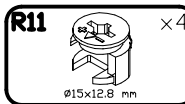
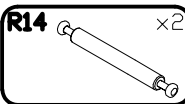
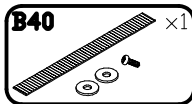



**PODCZAS MONTAŻU POSTĘPOWAĆ ZGODNIE Z INSTRUKCJĄ**

WHILE ASSEMBLING FOLLOW THE INSTRUCTION / MONTAGE LAUT DER AUFBAUANLEITUNG DURCHFÜHREN

PŘI MONTÁŽI POSTUPOVAT PODLE NÁVODU / PRI MONTÁŽI POSTUPUJTE PODĽA NÁVODU / SZERELÉSKOR UTASÍTÁS SZERINT ELJÁRNI

**3** Tfeco **THW-2P**

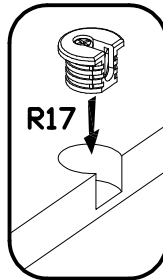
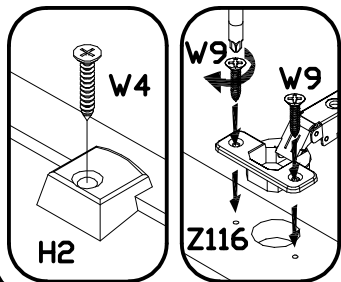
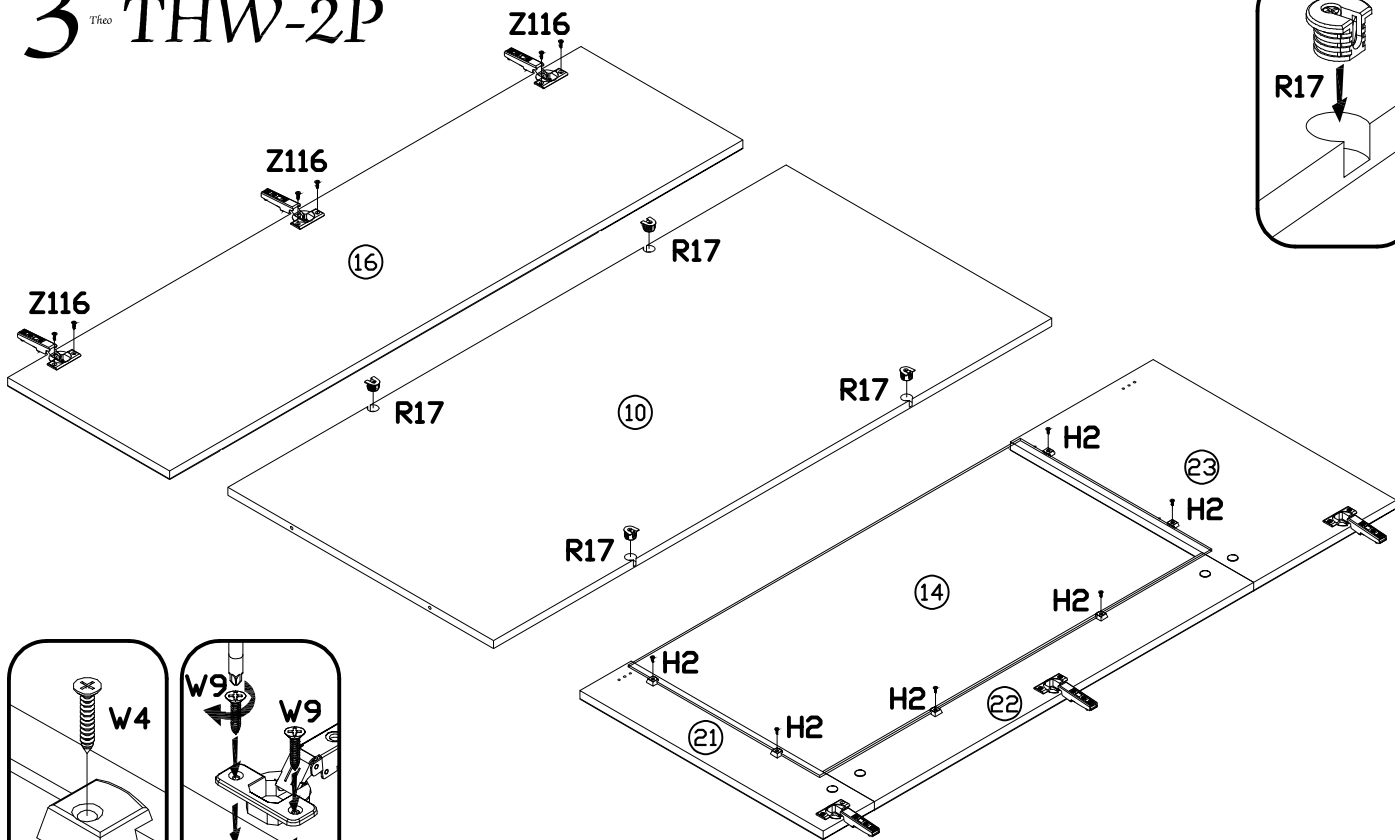

**4** Tfeco **THW-2P**

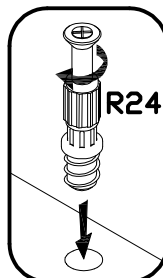
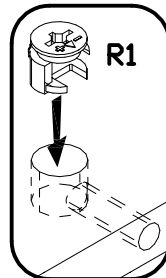
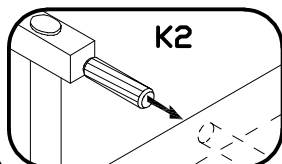
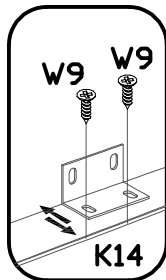
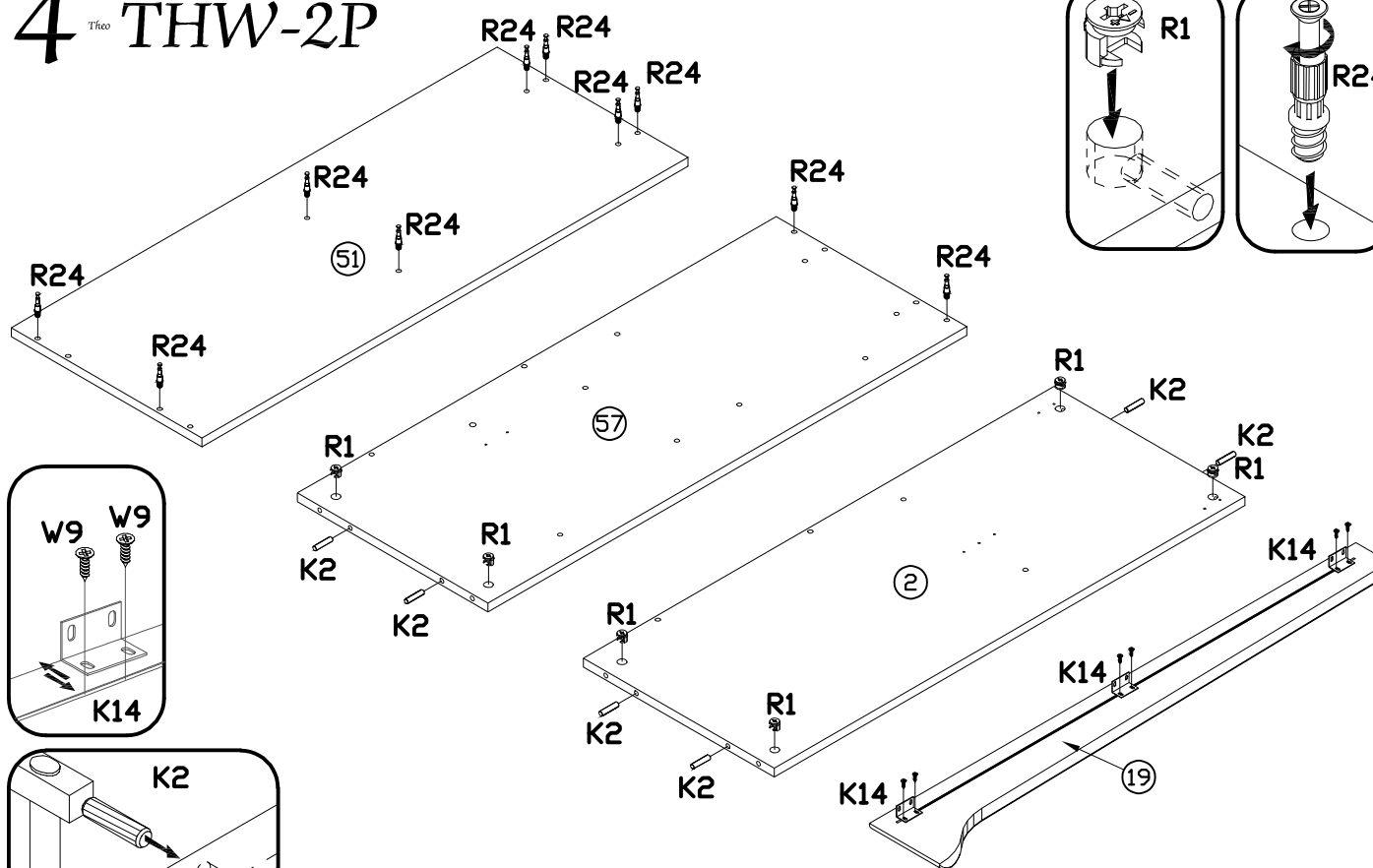

**PODCZAS MONTAŻU POSTĘPOWAĆ ZGODNIE Z INSTRUKCJĄ**

WHILE ASSEMBLING FOLLOW THE INSTRUCTION / MONTAGE LAUT DER AUFBAUANLEITUNG DURCHFÜHREN

PŘI MONTÁŽI POSTUPOVAT PODLE NÁVODU / PRI MONTÁŽI POSTUPUJTE PODĽA NÁVODU / SZERELÉSKOR UTASÍTÁS SZERINT ELJÁRNI

# 5 THW-2P

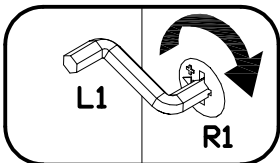
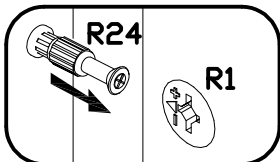
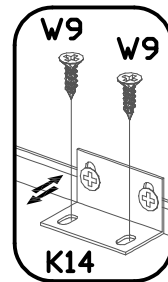
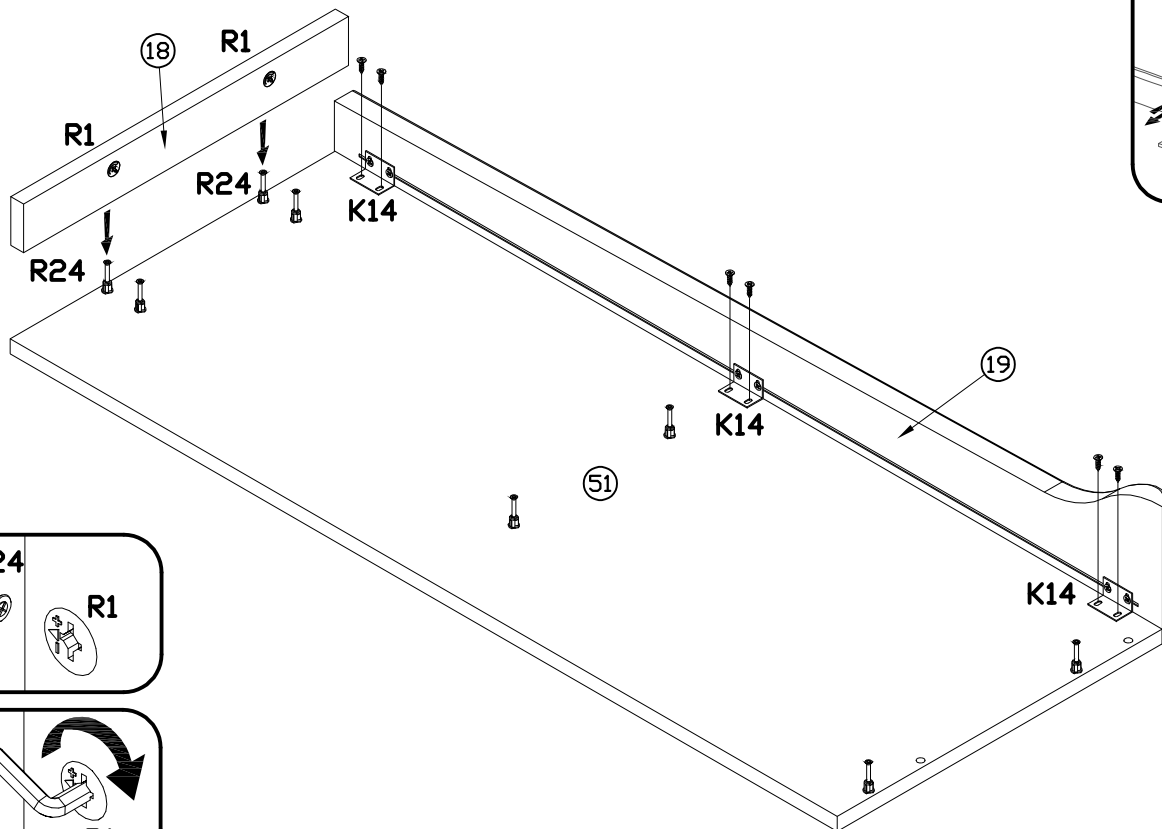

# 6 THW-2P - Opcja NEO-9

**NEO-9 OPCJA**

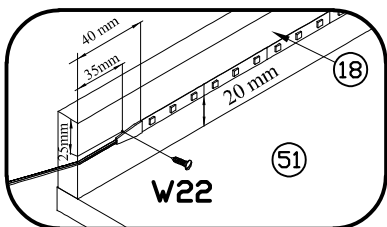
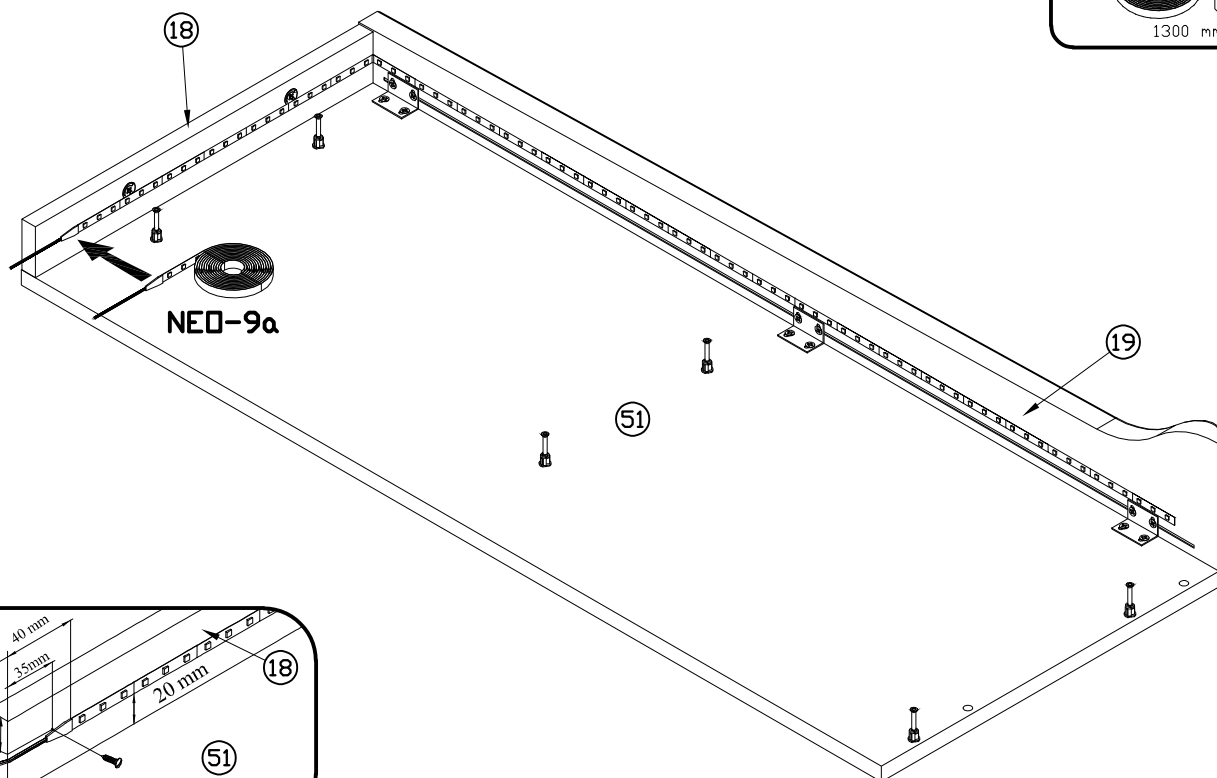
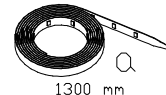

**PODCZAS MONTAŻU POSTĘPOWAĆ ZGODNIE Z INSTRUKCJĄ**

WHILE ASSEMBLING FOLLOW THE INSTRUCTION / MONTAGE LAUT DER AUFBAUANLEITUNG DURCHFÜHREN

PŘI MONTÁŽI POSTUPOVAT PODLE NÁVODU / PRI MONTÁŽI POSTUPOJTE PODĽA NÁVODU / SZERELÉSKOR UTASÍTÁS SZERINT ELJÁRNI

# 7 THW-2P

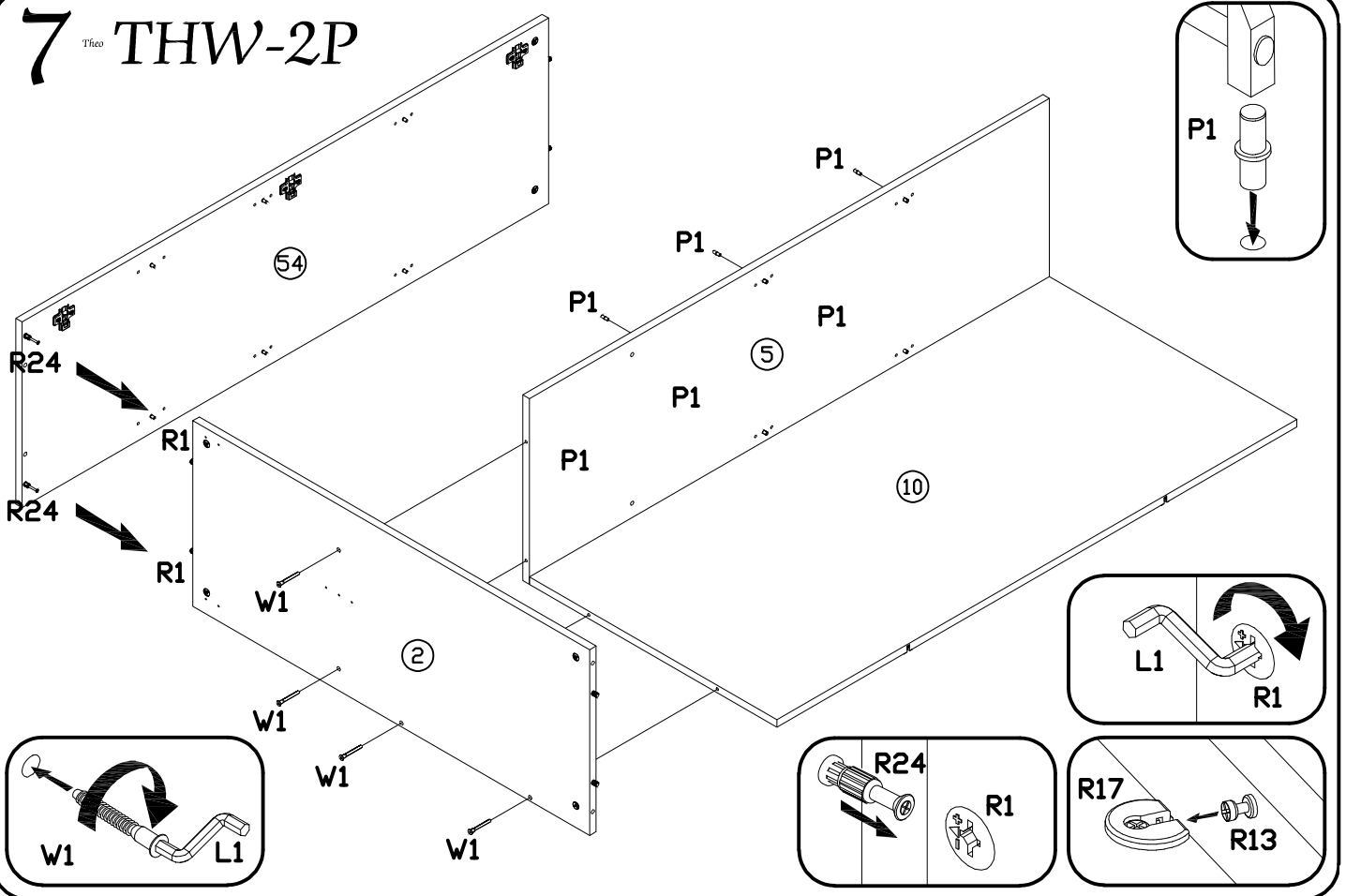

# 8 THW-2P - Opcja NEO-9

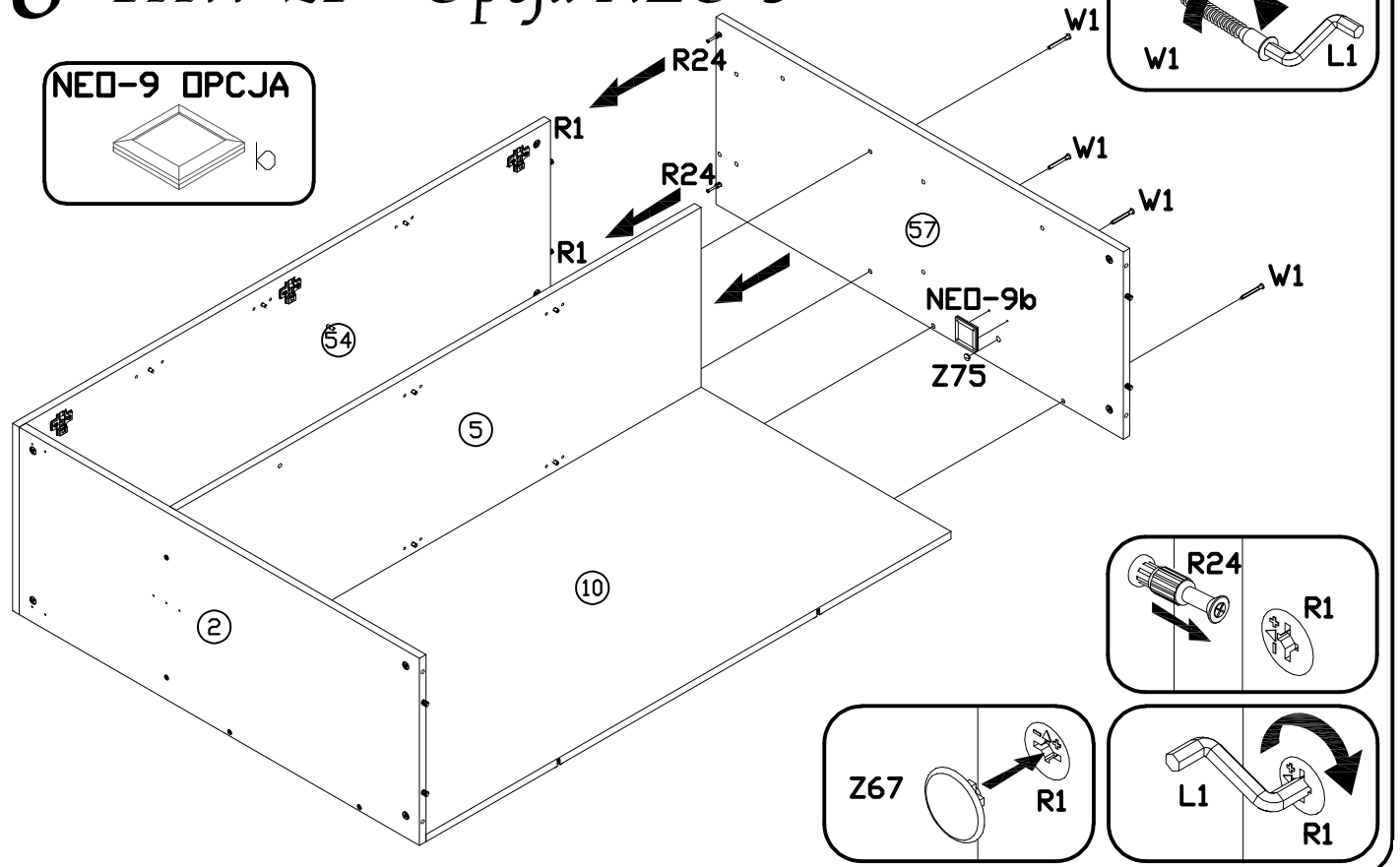

**PODCZAS MONTAŻU POSTĘPOWAĆ ZGODNIE Z INSTRUKCJĄ**

WHILE ASSEMBLING FOLLOW THE INSTRUCTION / MONTAGE LAUT DER AUFBAUANLEITUNG DURCHFÜHREN

PŘI MONTÁŽI POSTUPOVAT PODLE NÁVODU / PRI MONTÁŽI POSTUPOJTE PODĽA NÁVODU / SZERELÉSKOR UTASÍTÁS SZERINT ELJÁRNI

# 9 Tico THW-2P

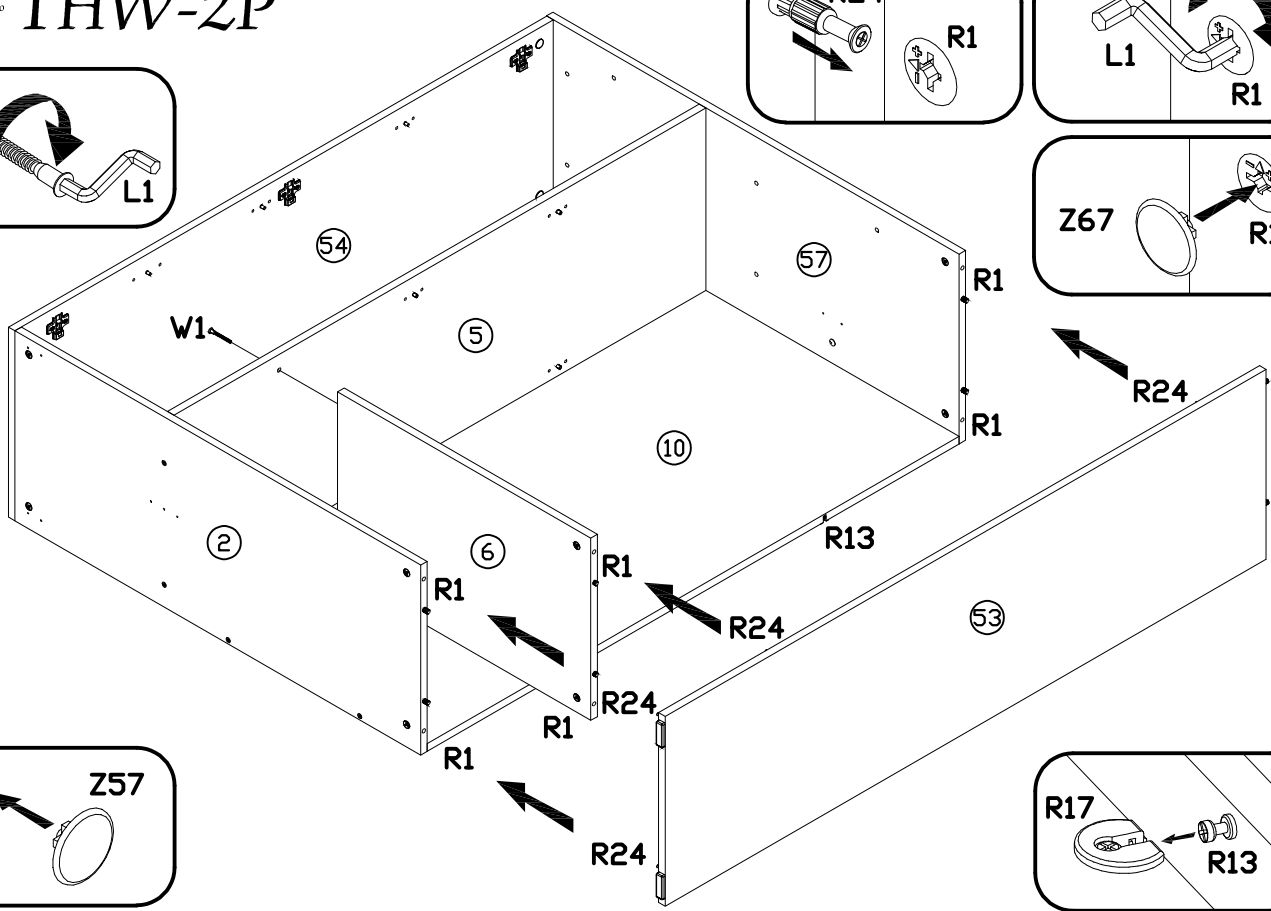
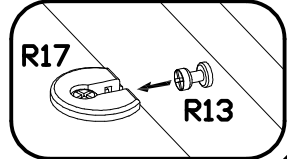
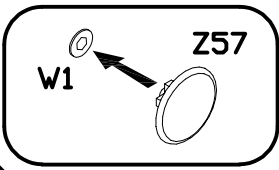
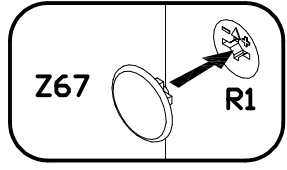
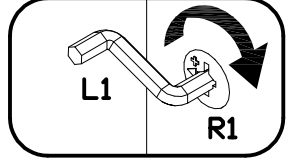
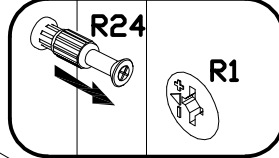
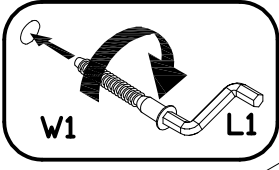

# 10 Tico THW-2P

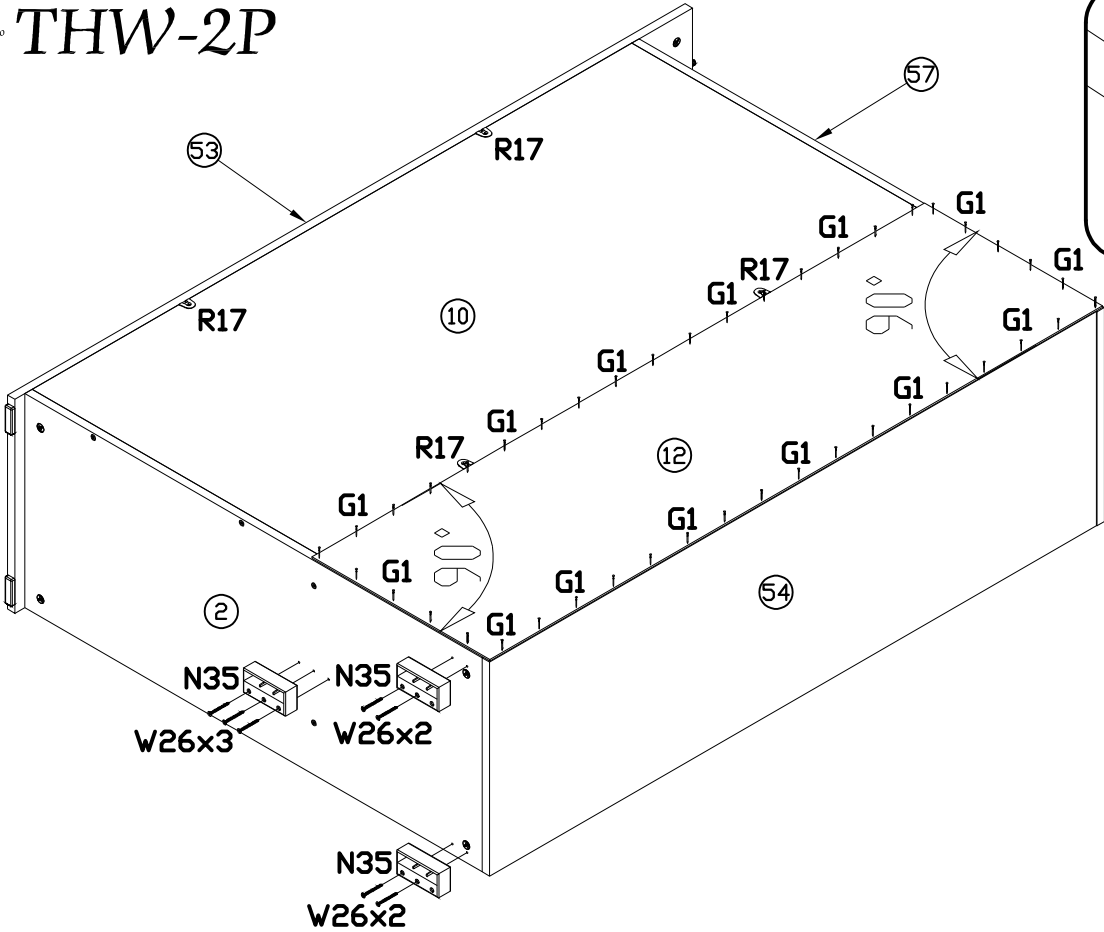
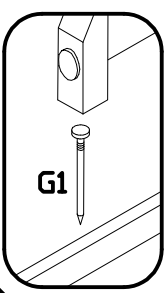
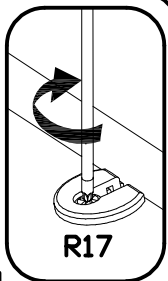

**PODCZAS MONTAŻU POSTĘPOWAĆ ZGODNIE Z INSTRUKCJĄ**

WHILE ASSEMBLING FOLLOW THE INSTRUCTION / MONTAGE LAUT DER AUFBAUANLEITUNG DURCHFÜHREN

PŘI MONTÁŽI POSTUPOVAT PODLE NÁVODU / PRI MONTÁŽI POSTUPUJTE PODĽA NÁVODU / SZERELÉSKOR UTASÍTÁS SZERINT ELJÁRNI

# 11<sup>TH</sup> THW-2P

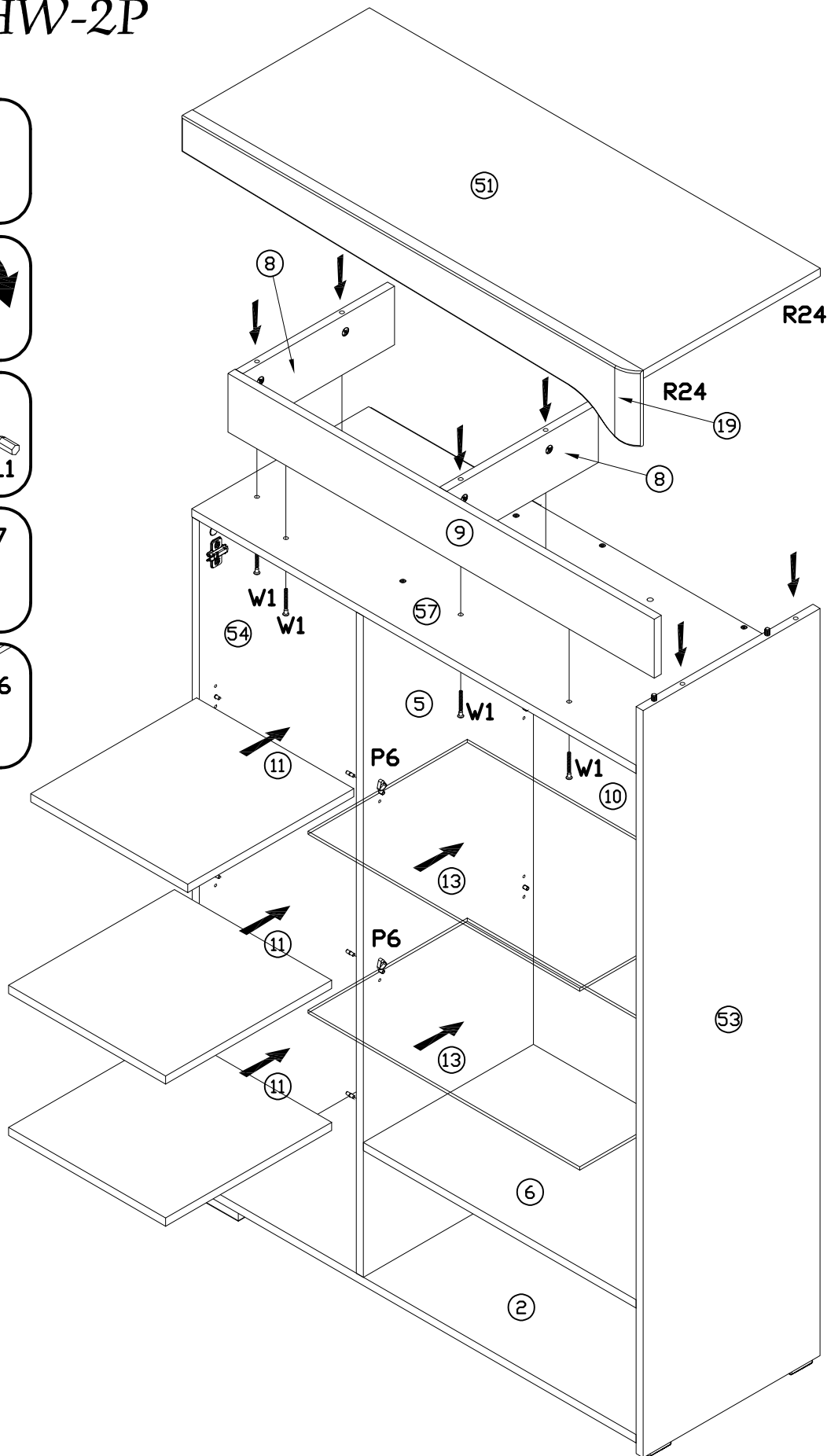
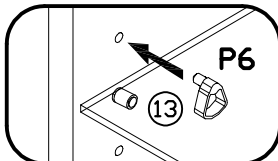
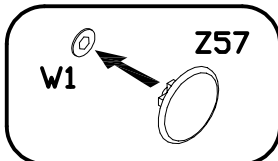
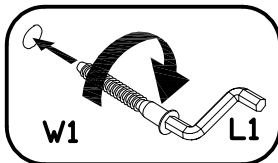
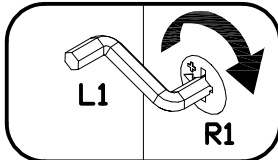
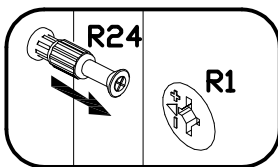

**PODCZAS MONTAŻU POSTĘPOWAĆ ZGODNIE Z INSTRUKCJĄ**

WHILE ASSEMBLING FOLLOW THE INSTRUCTION / MONTAGE LAUT DER AUFBAUANLEITUNG DURCHFÜHREN

PŘI MONTÁŽI POSTUPOVAT PODLE NÁVODU / PRI MONTÁŽI POSTUPOJTE PODĽA NÁVODU / SZERELÉSKOR UTASÍTÁS SZERINT ELJÁRNI

# 12<sup>TH</sup> THW-2P

