

# INSTRUKCJA MONTAŻU

FITTING-UP INSTRUCTION / AUFBAUANLEITUNG

MONTÁŽNÍ NÁVOD / MONTÁŽNY NÁVOD / SZERELÉSI UTASÍTÁS

**restol**®

Producent:

**Restol sp. z o.o.**

36-055 BRATKOWICE

www.restol.com.pl

# Theo THS-2

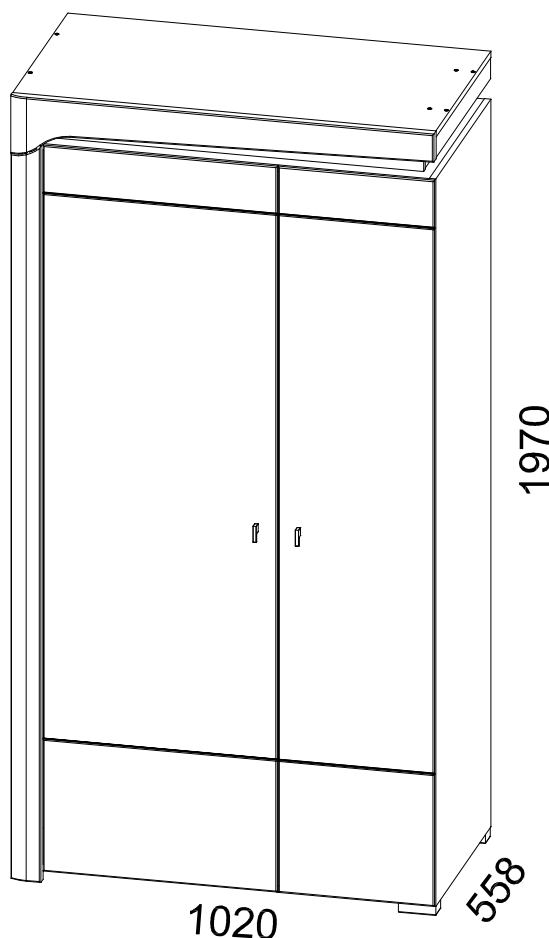

1020 x 1970 x 558 /mm/

#### **WSKAZÓWKA na temat pielęgnacji mebla.**

Czyścić elementy wilgotną szmatką lub papierowym ręcznikiem.  
Nie używać chemicznych środków czyszczących.

#### **DIRECTION for the furniture cleaning.**

Clean elements with the moist wiper or soft paper towel. Do not use any detergents.

#### **Pflegehinweis.**

Nur mit feuchtem Lappen, bzw. Papiertuch Ihre Möbel reinigen.  
Keine chemischen Waschmittel einsetzen.

#### **POKYN pro ošetřování nábytku!**

Díly čistit vlhkým hadříkem nebo papírovou utěrkou.  
Nepoužívat chemické čističí prostředky.

#### **POKYNY k údržbě nábytku.**

Prvky nábytku čistit vlhkou handričkou alebo papierovou utierkou  
Nepoužívať chemické čistiace prostriedky.

#### **UTMATATÓ a bútor ápolására.**

Az elemeket nedves ronggyal vagy papírtörülközővel tisztítani.  
Vegyitisztítószert nem használni.

Gwarancja dostępna pod linkiem:

Guarantee available at:

Die Garantie ist unter dem Link:

Záruka je k dispozici na následujícím odkazu:

Záruka k dispozícii pod odkazom:

Link a jótálláshoz :

[www.sklep.restol.com.pl/  
upload/gwarancja.pdf](http://www.sklep.restol.com.pl/upload/gwarancja.pdf)

# INSTRUKCJA MONTAŻU

FITTING-UP INSTRUCTION / AUFBAUANLEITUNG  
MONTÁŽNÍ NÁVOD / MONTÁŽNY NÁVOD / SZERELÉSI UTASÍTÁS

NR	WYMIARY	SZT	PACZKA
1	1019 x 530 x 16	1	1 / 4
2	987 x 530 x 16	1	1 / 4
6	355 x 520 x 16	1	1 / 4
7	987 x 530 x 16	1	1 / 4
8	473 x 104 x 16	1	3 / 4
9	963 x 104 x 16	1	3 / 4
10	355 x 520 x 16	3	1 / 4
11	1820 x 636 x 3	1	3 / 4
12	1820 x 376 x 3	1	3 / 4
13	608 x 30 x 15	2	3 / 4
14	1819 x 564 x 18	1	4 / 4
15	1819 x 376 x 18	1	3 / 4
16	1845,5 x 74 x 22	1	3 / 4
17	530 x 52 x 16	1	1 / 4
18	1020 x 147,2 x 22	1	3 / 4
53	1947 x 530 x 16	1	2 / 4
54	1823 x 530 x 16	1	2 / 4
55	1790 x 530 x 16	1	4 / 4

Do montażu potrzebne są:

You need for fitting-up:

Zur Montage werden Sie brauchen:

K montáži jsou potřebné:

Na montáž potrebujete:

A szereléshez szükséges:

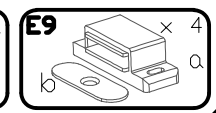
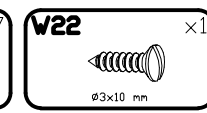
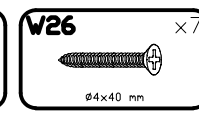
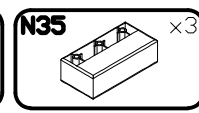
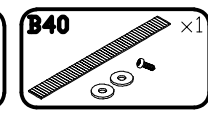
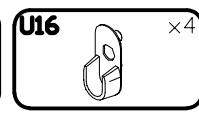
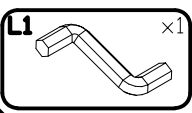
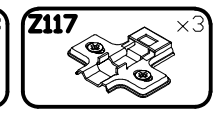
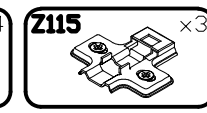
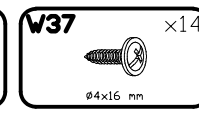
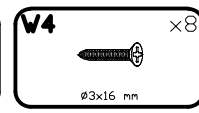
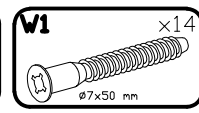
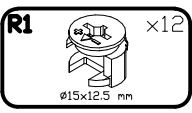
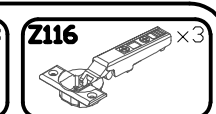
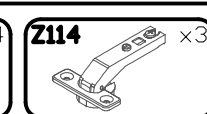
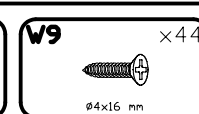
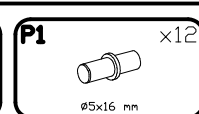
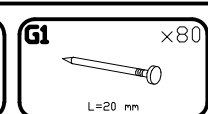
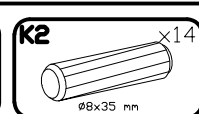
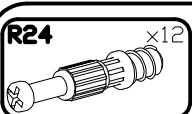
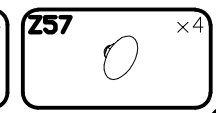
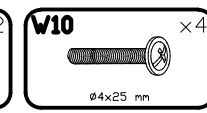
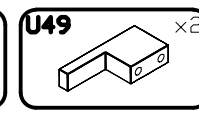
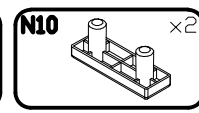
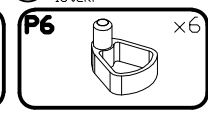
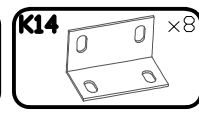
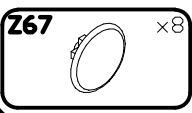
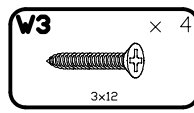
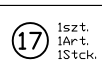
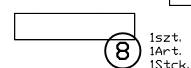
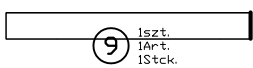
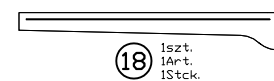
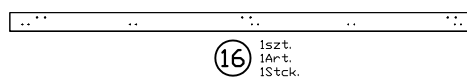
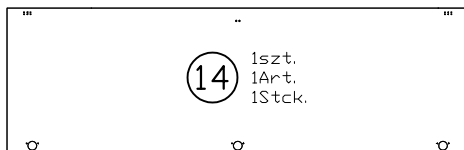
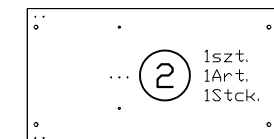
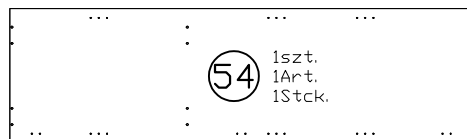
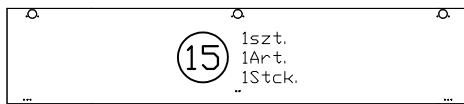
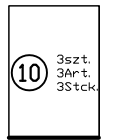
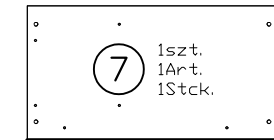
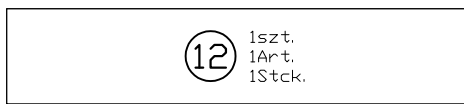
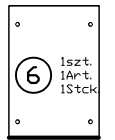
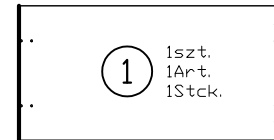
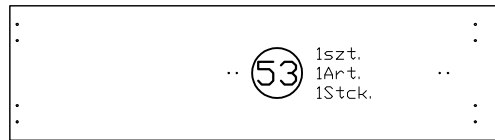
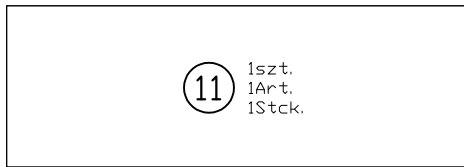
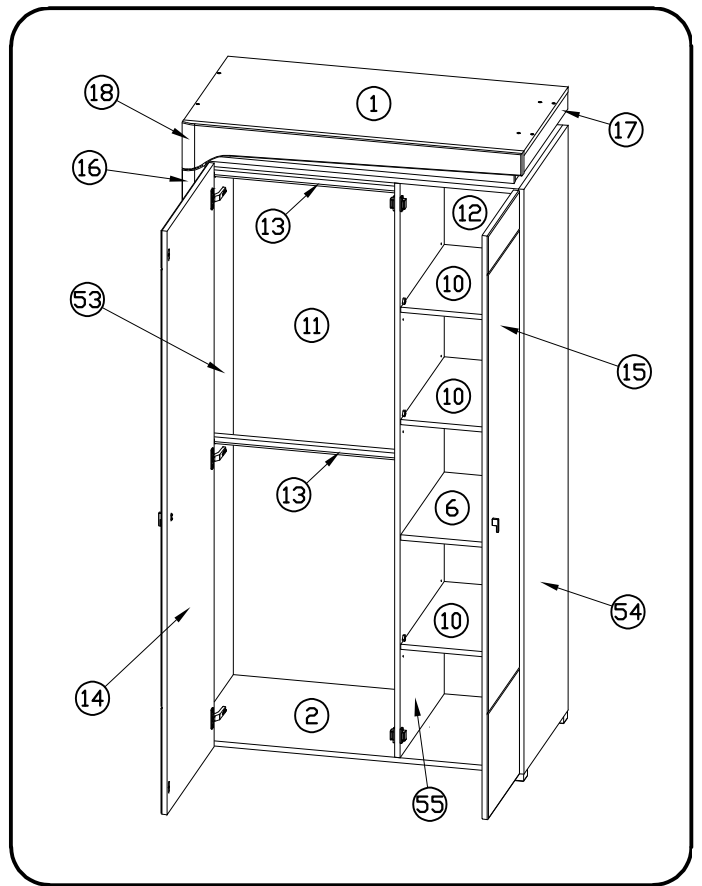
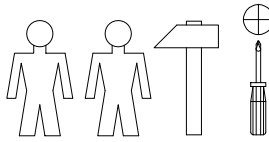

**PODCZAS MONTAŻU POSTĘPOWAĆ ZGODNIE Z INSTRUKCJĄ**

WHILE ASSEMBLING FOLLOW THE INSTRUCTION / MONTAGE LAUT DER AUFBAUANLEITUNG DURCHFÜHREN

PŘI MONTÁŽI POSTUPOVAT PODLE NÁVODU / PRI MONTÁŽI POSTUPOJTE PODĽA NÁVODU / SZERELÉSKOR UTASÍTÁS SZERINT ELJÁRNI

**1** Tfco **THS-2**

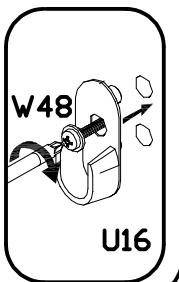
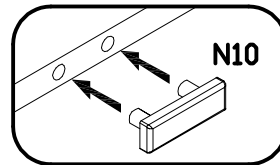
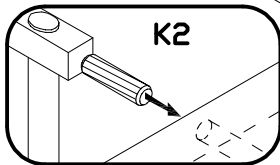
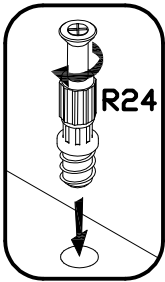
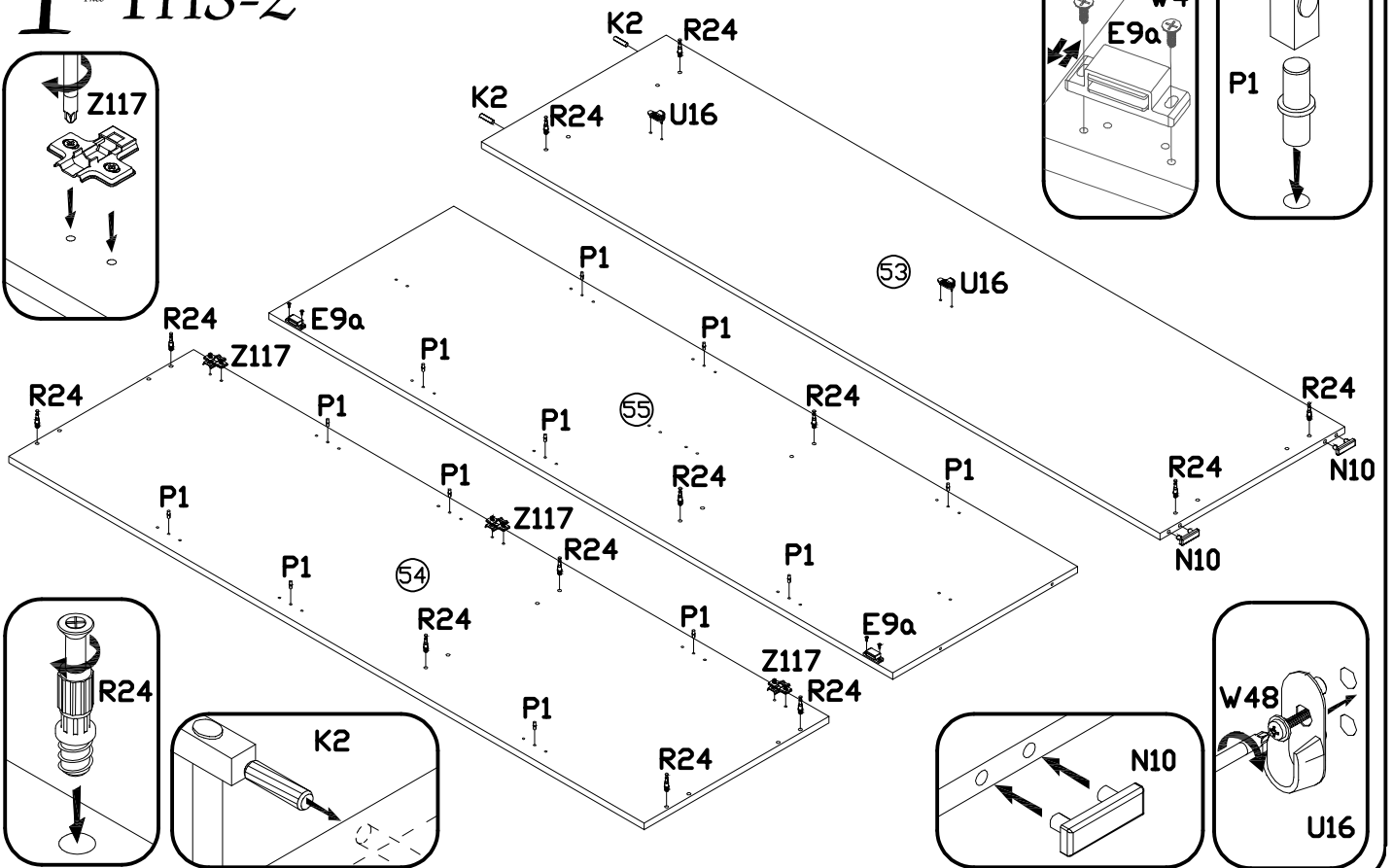
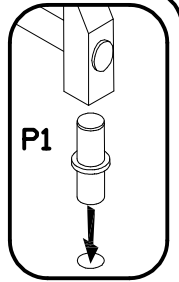
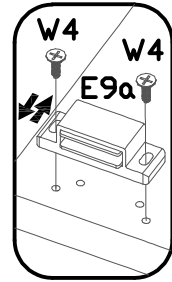
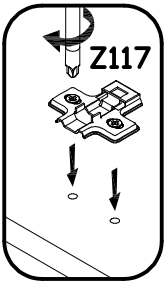

**2** Tfco **THS-2**

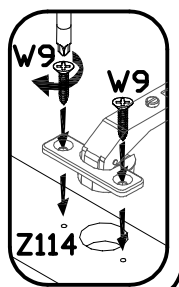
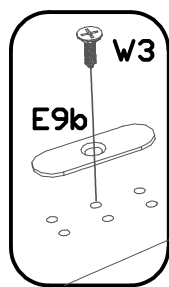
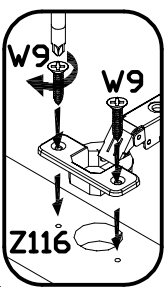
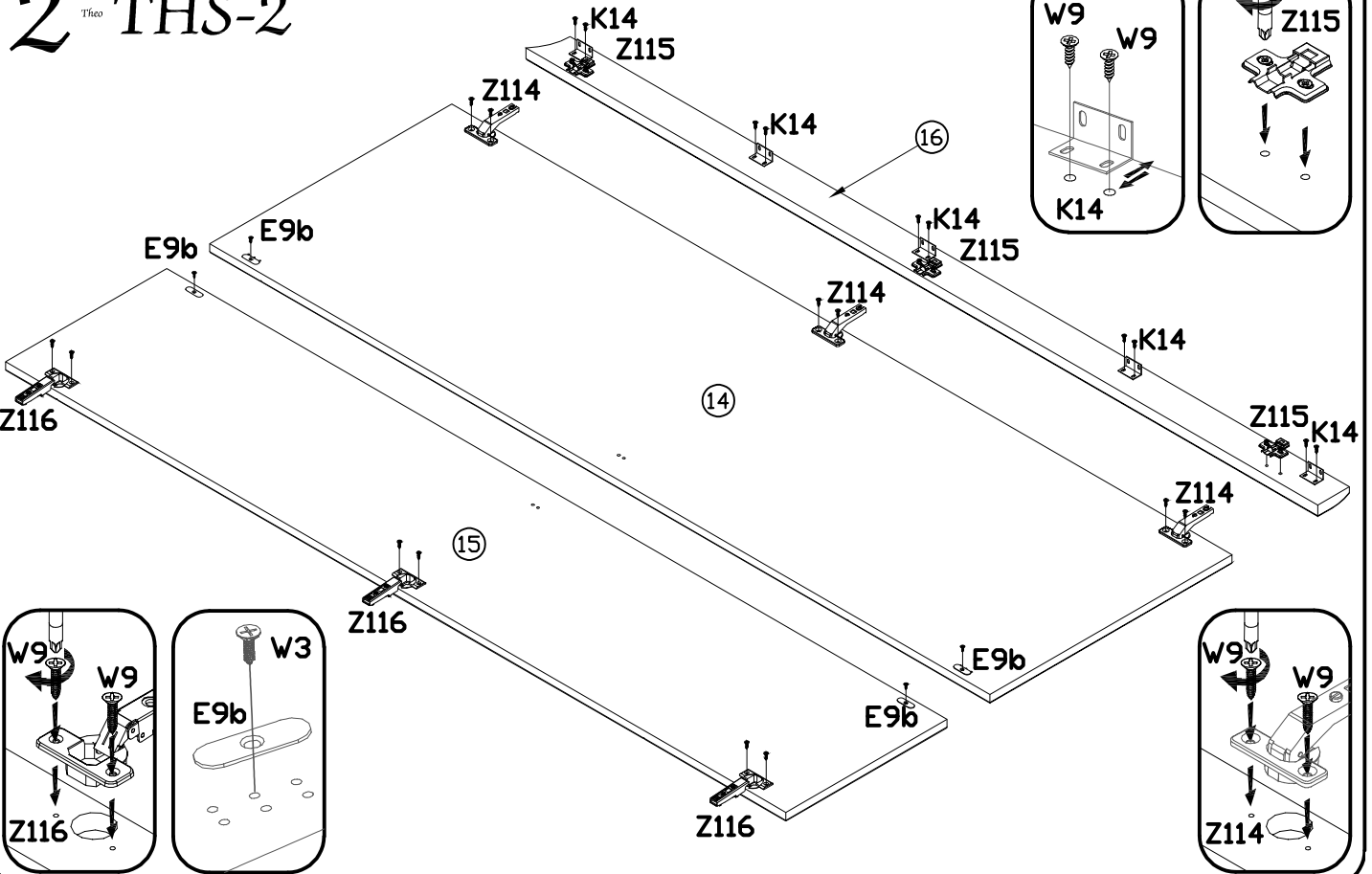
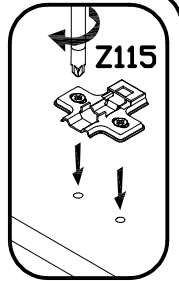
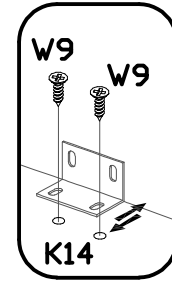

**PODCZAS MONTAŻU POSTĘPOWAĆ ZGODNIE Z INSTRUKCJĄ**

WHILE ASSEMBLING FOLLOW THE INSTRUCTION / MONTAGE LAUT DER AUFBAUANLEITUNG DURCHFÜHREN

PŘI MONTÁŽI POSTUPOVAT PODLE NÁVODU / PRI MONTÁŽI POSTUPOJTE PODĽA NÁVODU / SZERELÉSKOR UTASÍTÁS SZERINT ELJÁRNI

**3** Tfco **THS-2**

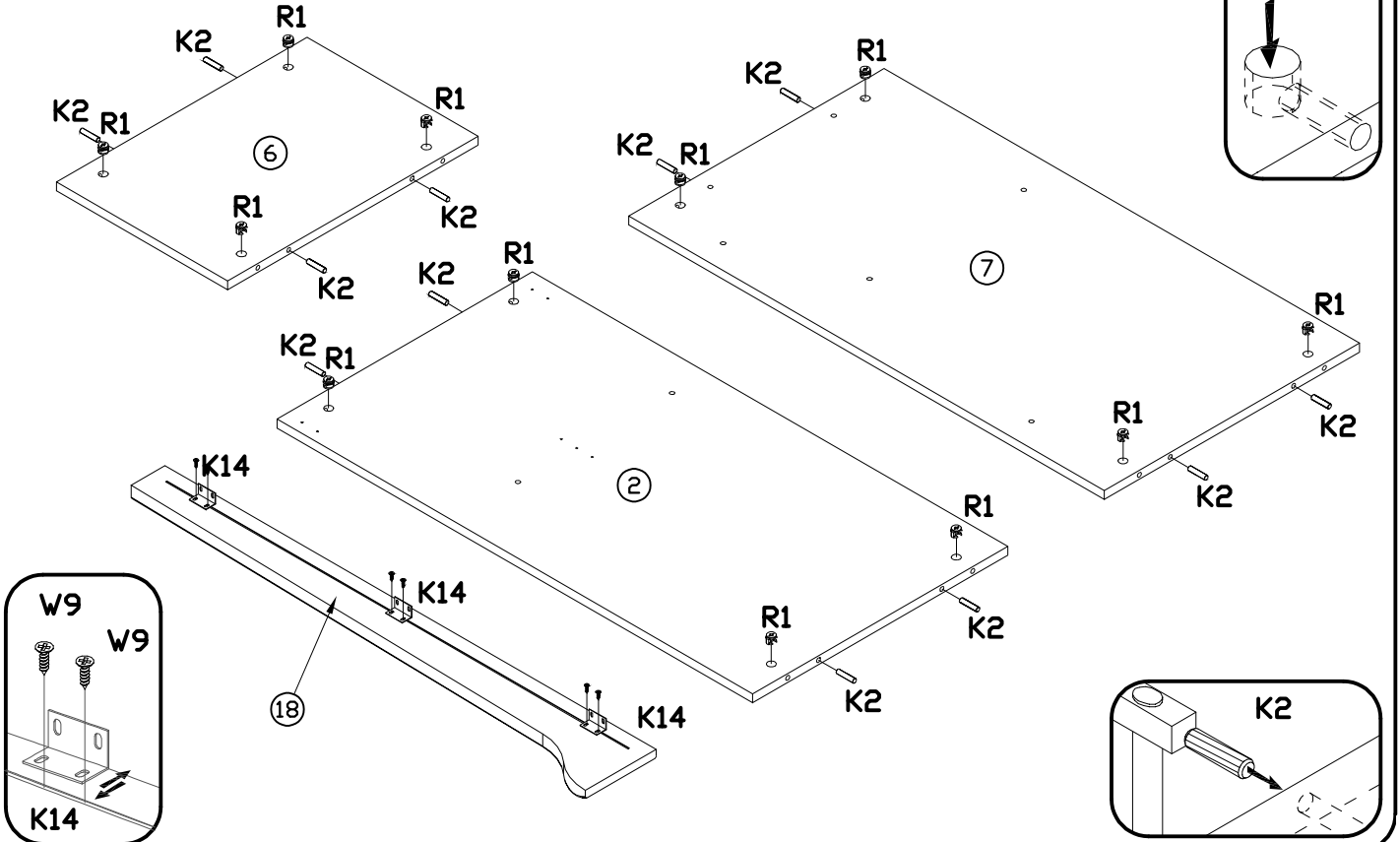

**4** Tfco **THS-2**

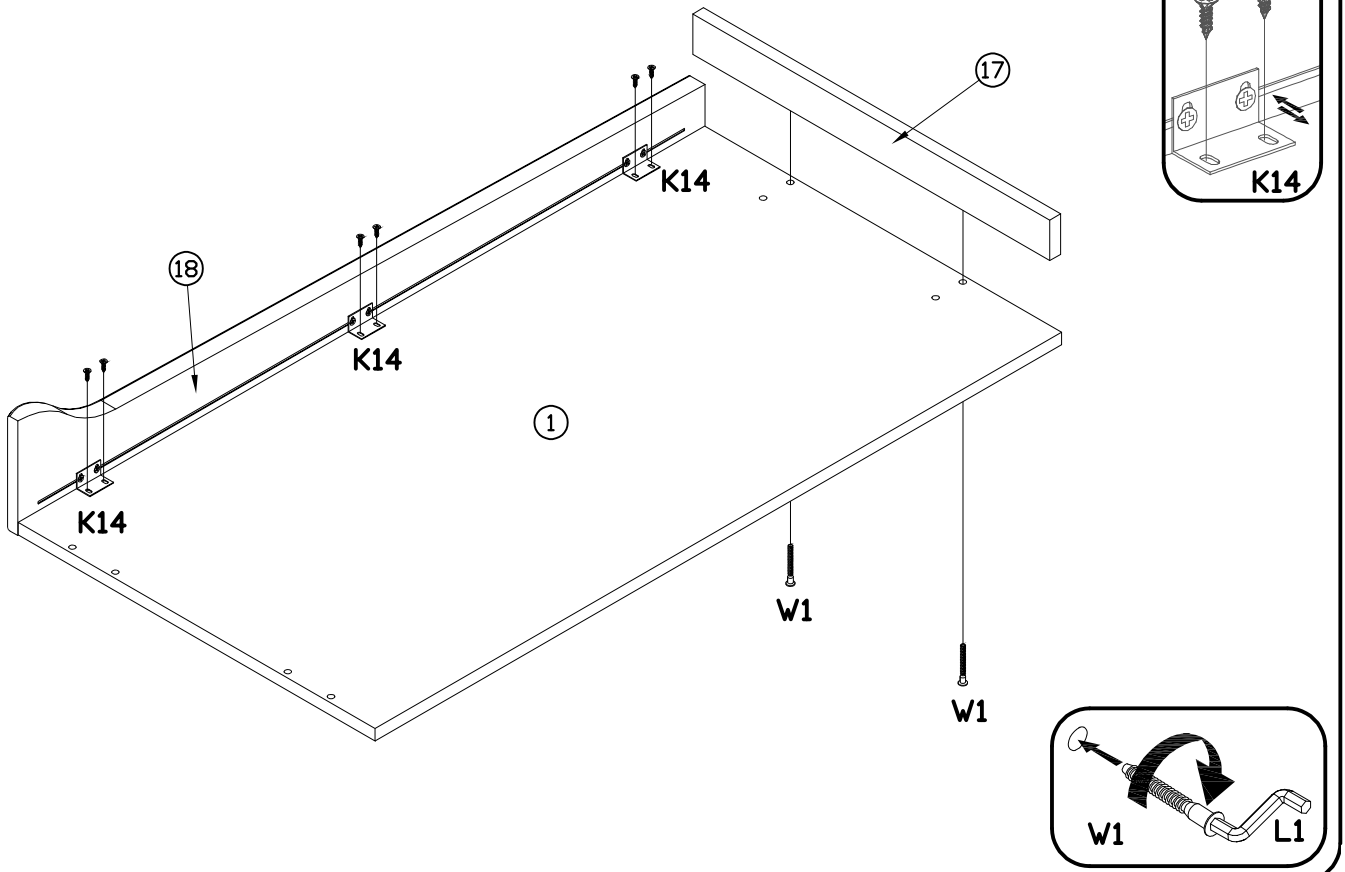

**PODCZAS MONTAŻU POSTĘPOWAĆ ZGODNIE Z INSTRUKCJĄ**

WHILE ASSEMBLING FOLLOW THE INSTRUCTION / MONTAGE LAUT DER AUFBAUANLEITUNG DURCHFÜHREN

PŘI MONTÁŽI POSTUPOVAT PODLE NÁVODU / PRI MONTÁŽI POSTUPUJTE PODĽA NÁVODU / SZERELÉSKOR UTASÍTÁS SZERINT ELJÁRNI

# 5<sup>Tfco</sup> THS-2 - Opcja NEO-8

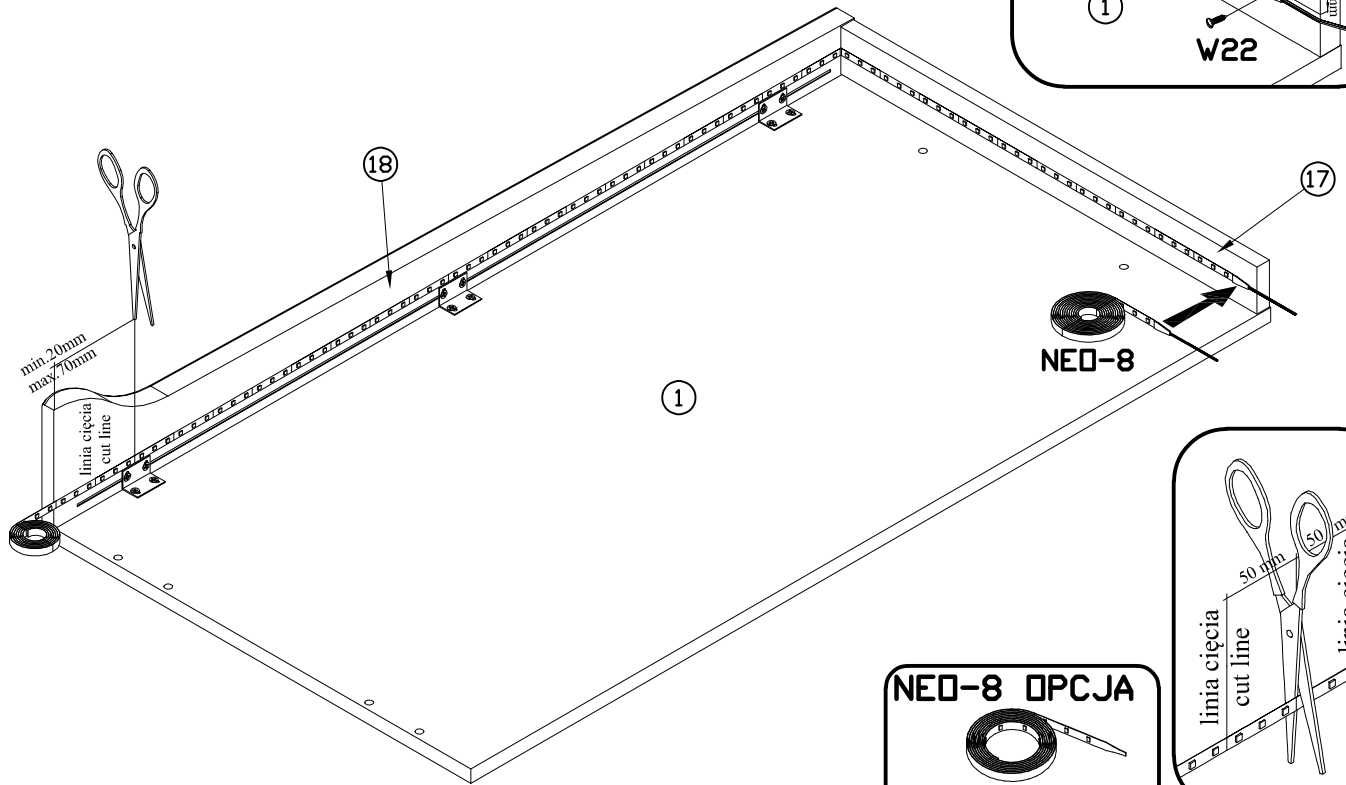
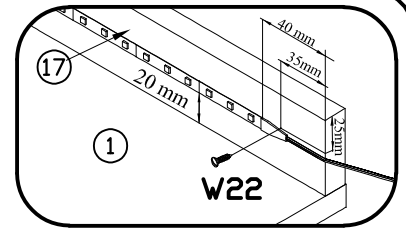

# 6<sup>Tfco</sup> THS-2

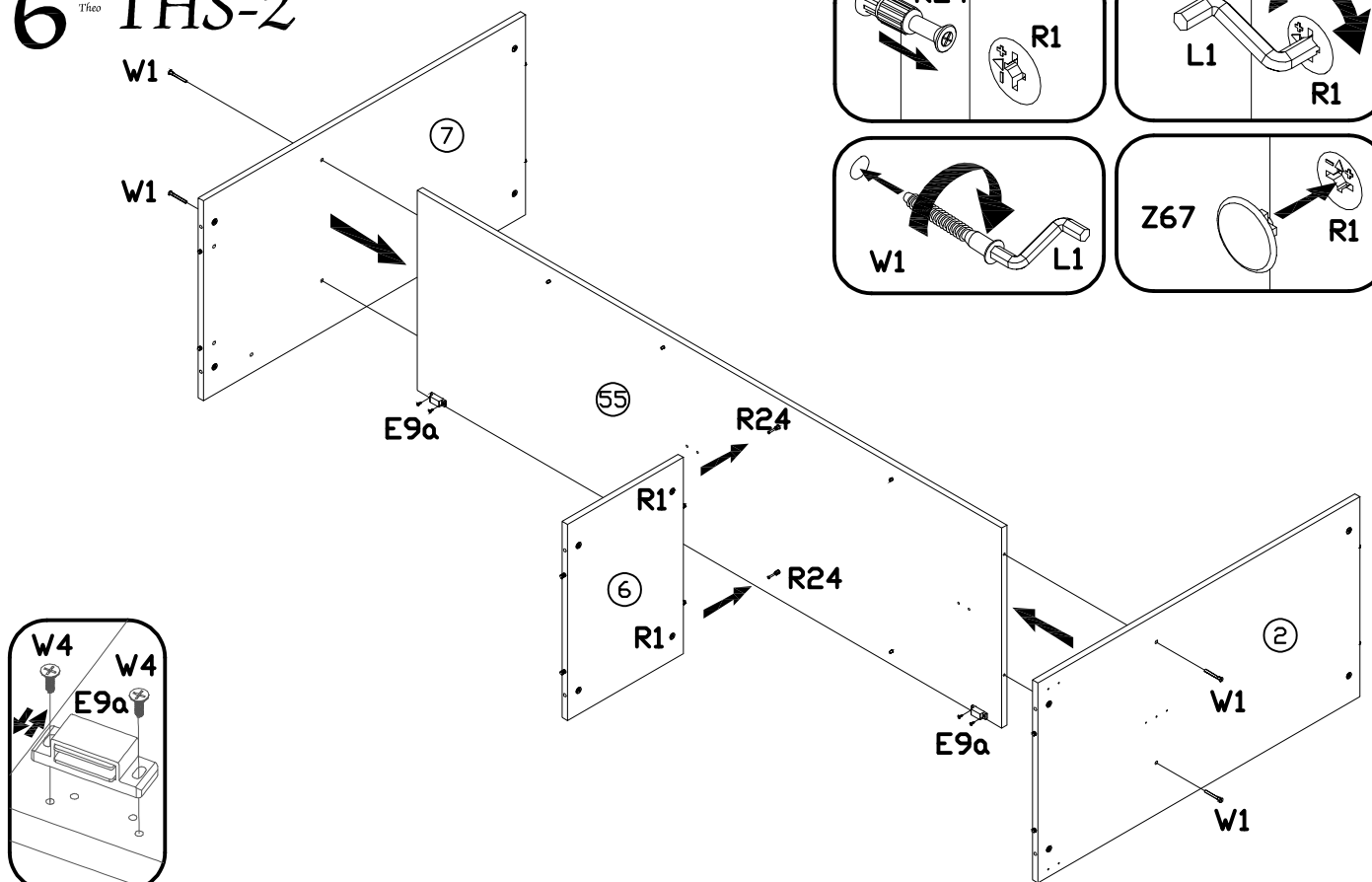
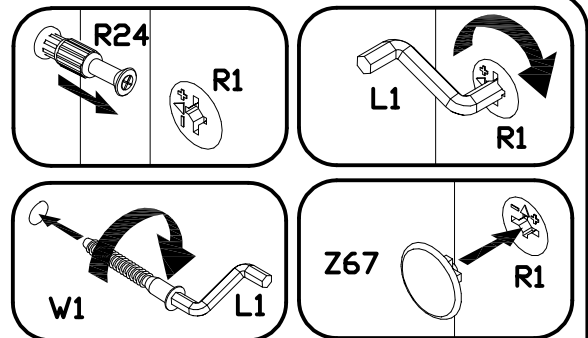

**PODCZAS MONTAŻU POSTĘPOWAĆ ZGODNIE Z INSTRUKCJĄ**

WHILE ASSEMBLING FOLLOW THE INSTRUCTION / MONTAGE LAUT DER AUFBAUANLEITUNG DURCHFÜHREN

PŘI MONTÁŽI POSTUPOVAT PODLE NÁVODU / PRI MONTÁŽI POSTUPOJTE PODĽA NÁVODU / SZERELÉSKOR UTASÍTÁS SZERINT ELJÁRNI

**7** Tfeco **THS-2**

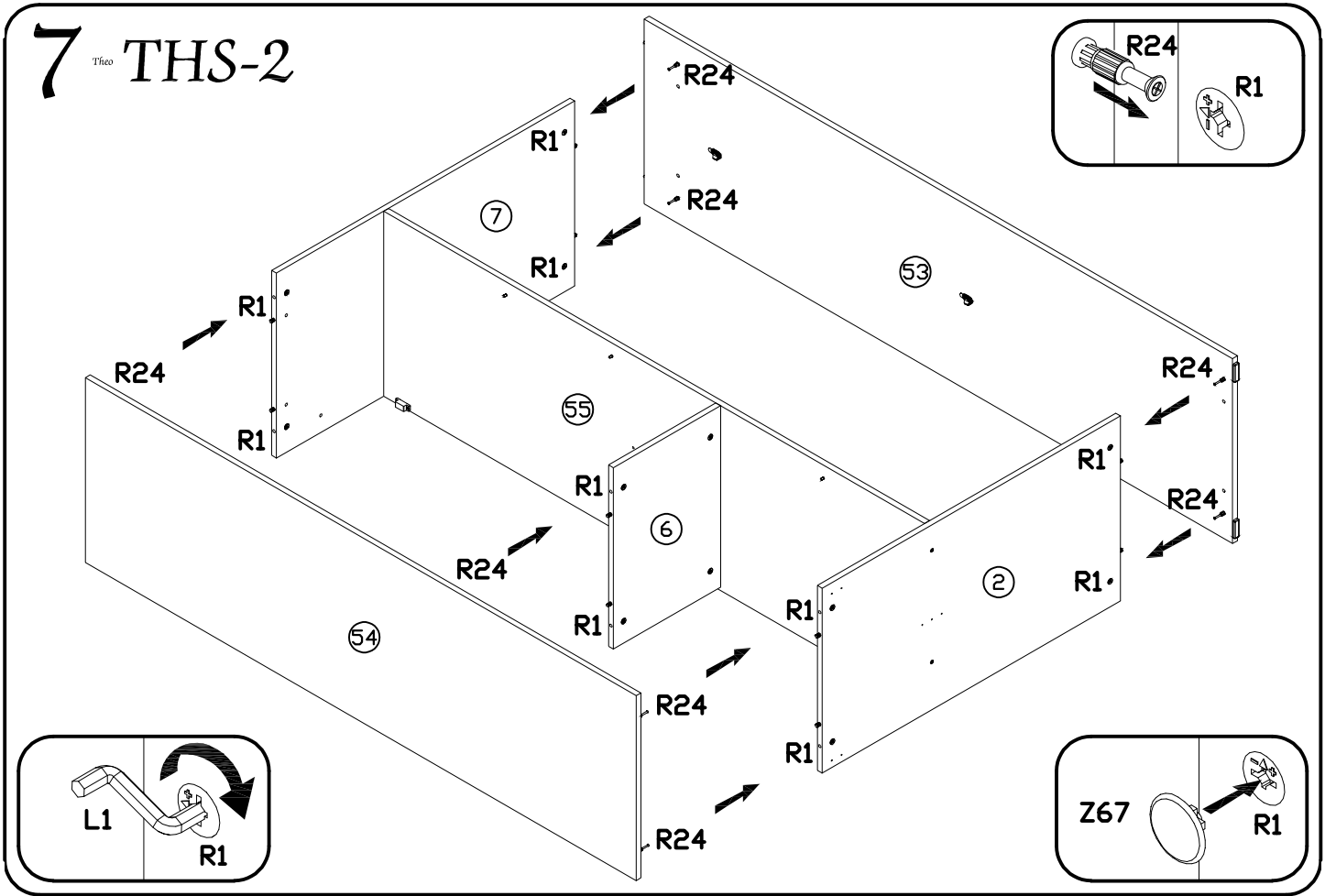

**8** Tfeco **THS-2**

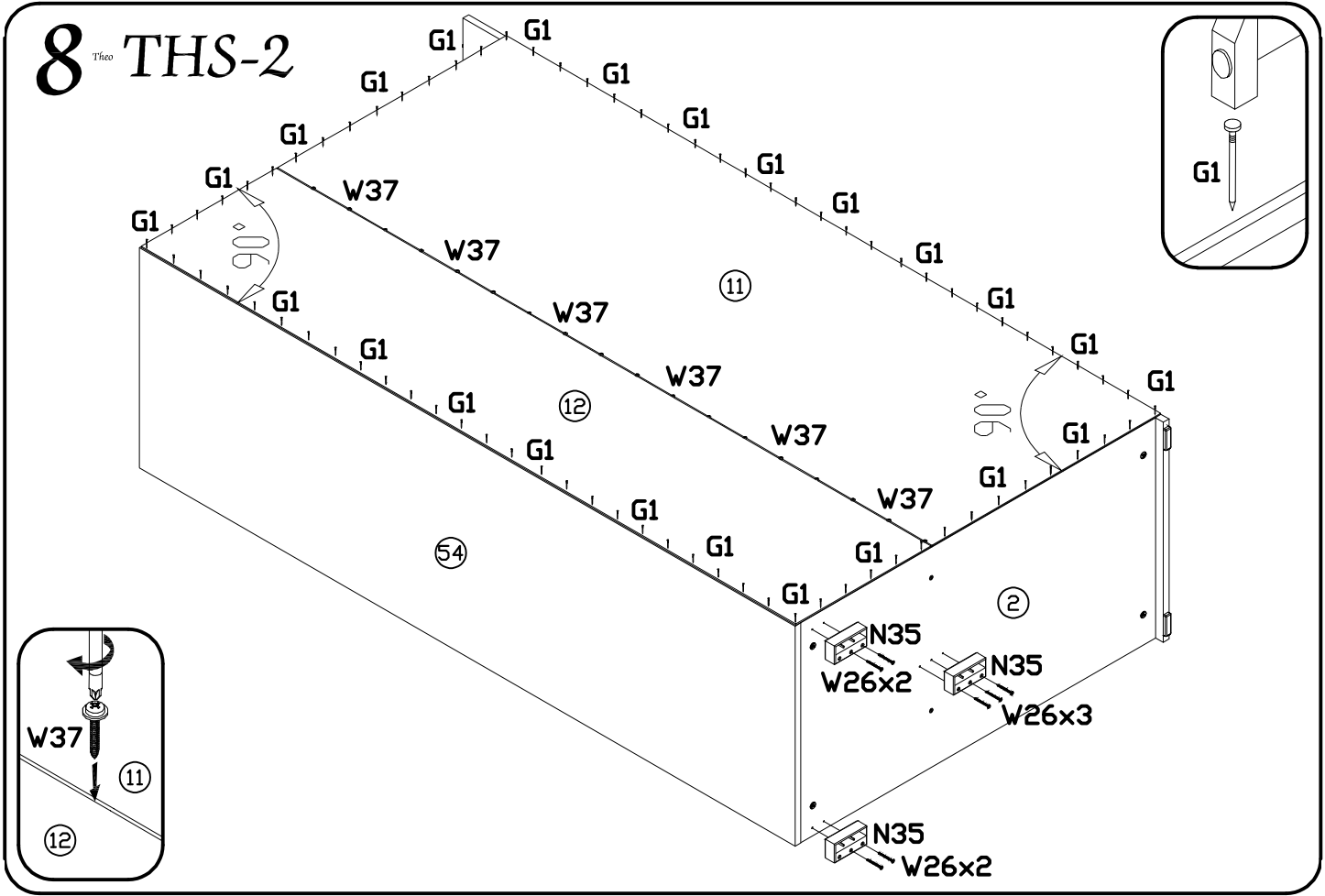

**PODCZAS MONTAŻU POSTĘPOWAĆ ZGODNIE Z INSTRUKCJĄ**

WHILE ASSEMBLING FOLLOW THE INSTRUCTION / MONTAGE LAUT DER AUFBAUANLEITUNG DURCHFÜHREN

PŘI MONTÁŽI POSTUPOVAT PODLE NÁVODU / PRI MONTÁŽI POSTUPOJTE PODĽA NÁVODU / SZERELÉSKOR UTASÍTÁS SZERINT ELJÁRNI

# 9<sup>TH</sup> THS-2

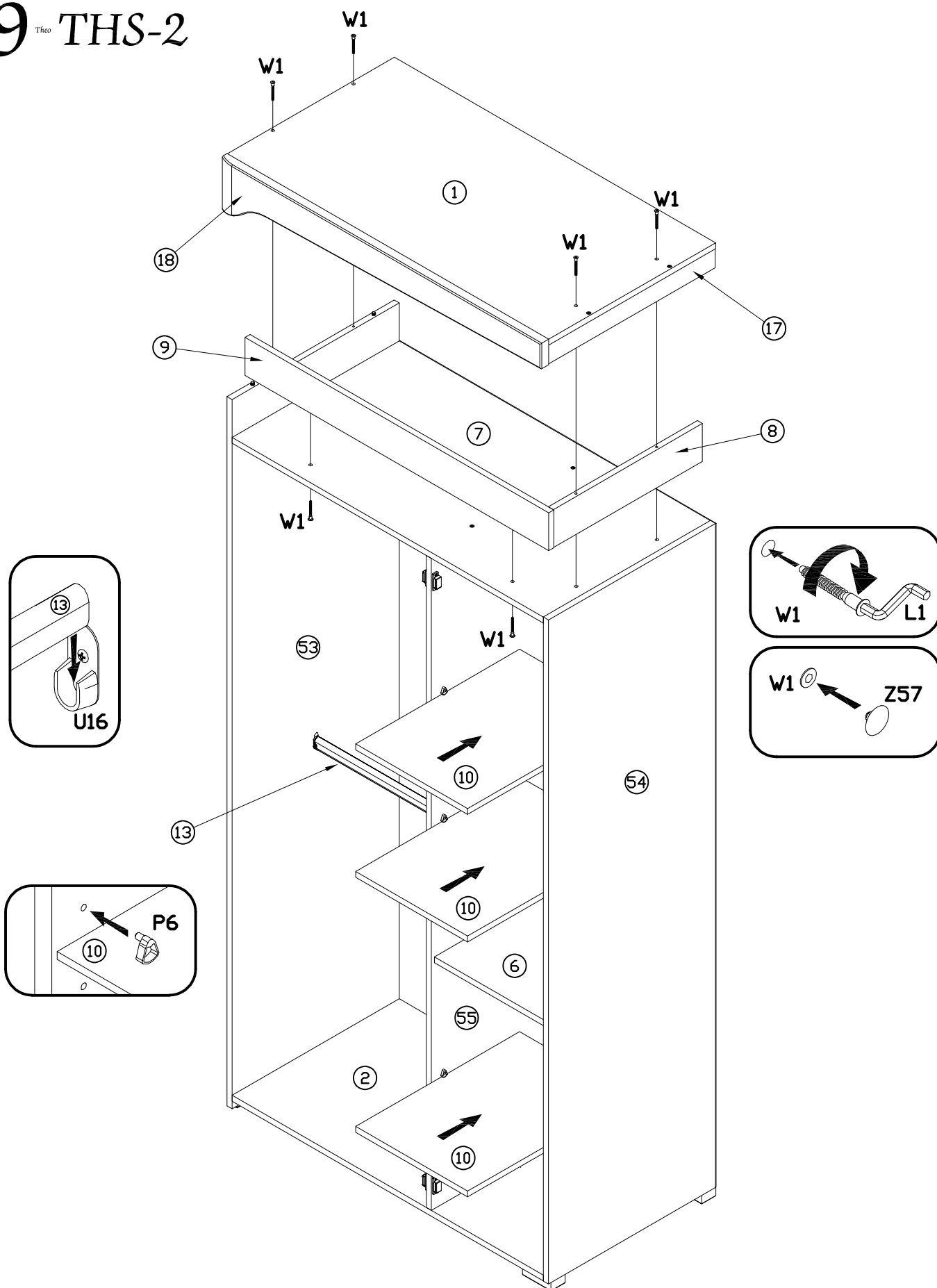

**PODCZAS MONTAŻU POSTĘPOWAĆ ZGODNIE Z INSTRUKCJĄ**

WHILE ASSEMBLING FOLLOW THE INSTRUCTION / MONTAGE LAUT DER AUFBAUANLEITUNG DURCHFÜHREN

PŘI MONTÁŽI POSTUPOVAT PODLE NÁVODU / PRI MONTÁŽI POSTUPOJTE PODĽA NÁVODU / SZERELÉSKOR UTASÍTÁS SZERINT ELJÁRNI

# 10<sup>TH</sup> THS-2

