

# INSTRUKCJA MONTAŻU

FITTING-UP INSTRUCTION / AUFBAUANLEITUNG

MONTÁŽNÍ NÁVOD / MONTÁŽNY NÁVOD / SZERELÉSI UTASÍTÁS

Producent:  
**Restol sp. z o.o.**  
36-055 BRATKOWICE  
www.restol.com.pl

Kuchnia **RESTOL**  
**KU-D45**

**restol**®

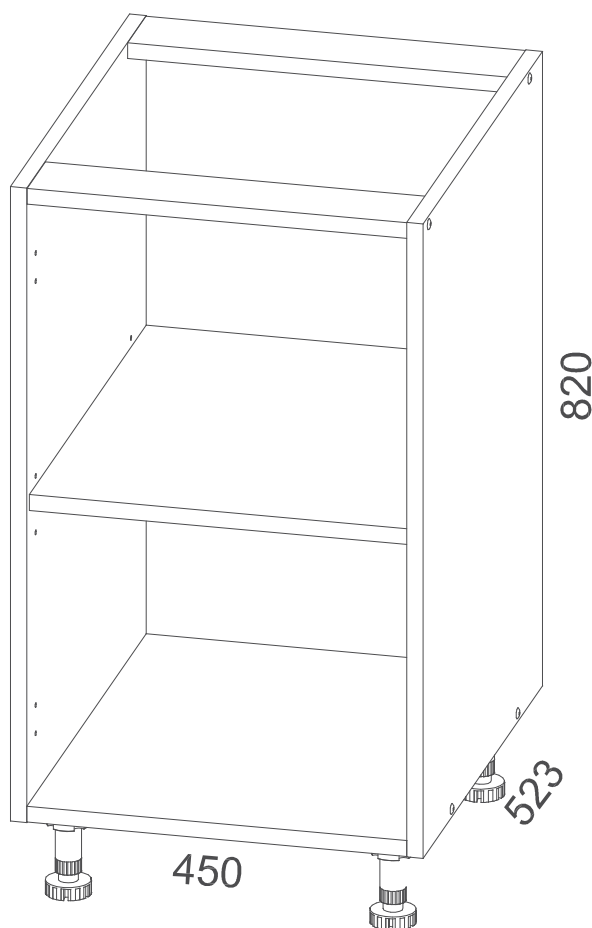

450 x 820 x 523 /mm/

#### **WSKAZÓWKA na temat pielęgnacji mebla.**

Czyścić elementy wilgotną szmatką lub papierowym ręcznikiem.

Nie używać chemicznych środków czyszczących.

#### **DIRECTION for the furniture cleaning.**

Clean elements with the moist wiper or soft paper towel. Do not use any detergents.

#### **Pflegehinweis.**

Nur mit feuchtem Lappen, bzw. Papiertuch Ihre Möbel reinigen.

Keine chemischen Waschmittel einsetzen.

#### **POKYN pro ošetřování nábytku.**

Díly čistit vlhkým hadříkem nebo papírovou utěrkou.

Nepoužívat chemické čističe prostředky.

#### **POKYNY k údržbě nábytku.**

Prvky nábytku čistit vlhkou handričkou alebo papierovou utierkou.

Nepoužívať chemické čistiace prostriedky.

#### **UTMATATÓ a bútor ápolására.**

Az elemeket nedves ronggyal vagy papírtörülközővel tisztítani.

Vegyí tisztítószeret nem használni.

Gwarancja dostępna pod linkiem:

Guarantee available at:

Die Garantie ist unter dem Link:

Záruka je k dispozíci na následujícím odkazu:

Záruka k dispozícii pod odkazom:

Link a jótálláshoz :

**[www.sklep.restol.com.pl/  
upload/gwarancja.pdf](http://www.sklep.restol.com.pl/upload/gwarancja.pdf)**

**INSTRUKCJA MONTAŻU**  
 FITTING-UP INSTRUCTION / AUFBAUANLEITUNG  
 MONTÁŽNÍ NÁVOD / MONTÁŽNY NÁVOD / SZERELÉSI UTASÍTÁS

**restol®**

# Kuchnia RESTOL KU-D45

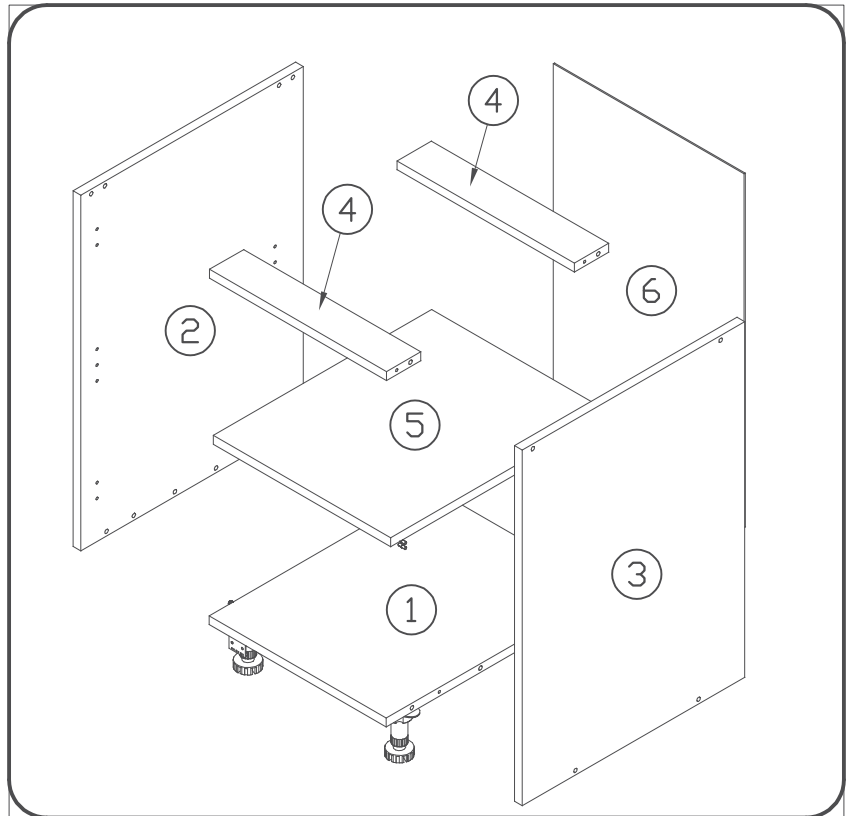
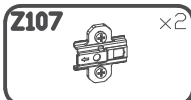
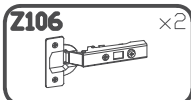
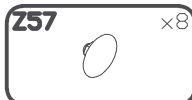
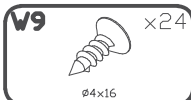
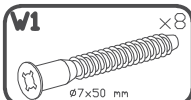
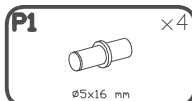
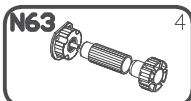
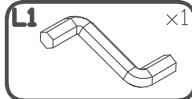
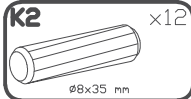
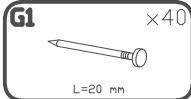

Do montażu potrzebne są:  
 You need for fitting-up:  
 Zur Montage werden Sie brauchen:  
 K montáži jsou potřebné:  
 Na montáž potrebujete:  
 A szereléshez szükséges:

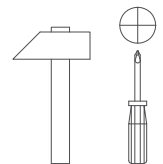
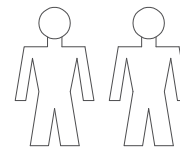

**1**

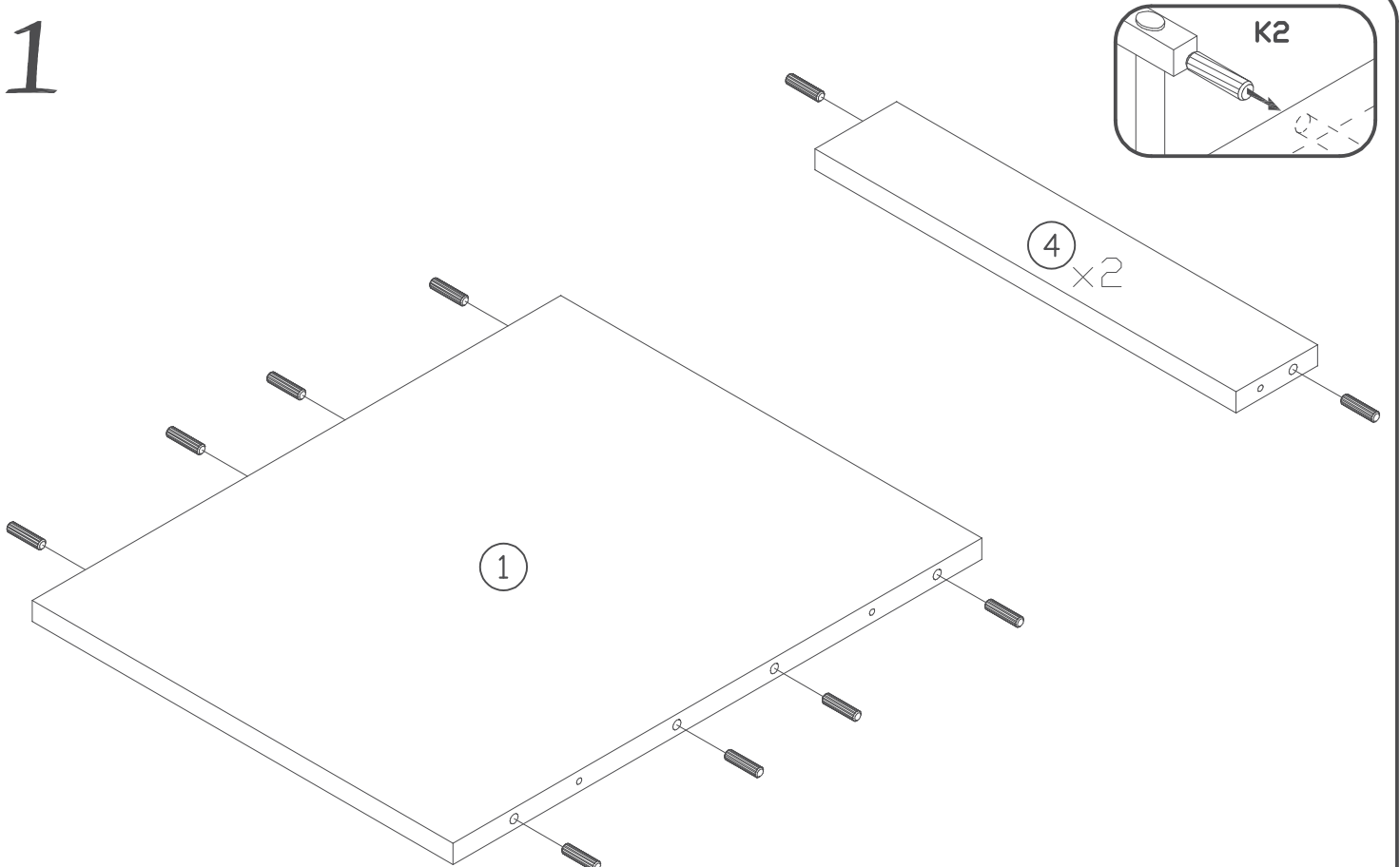

# 2

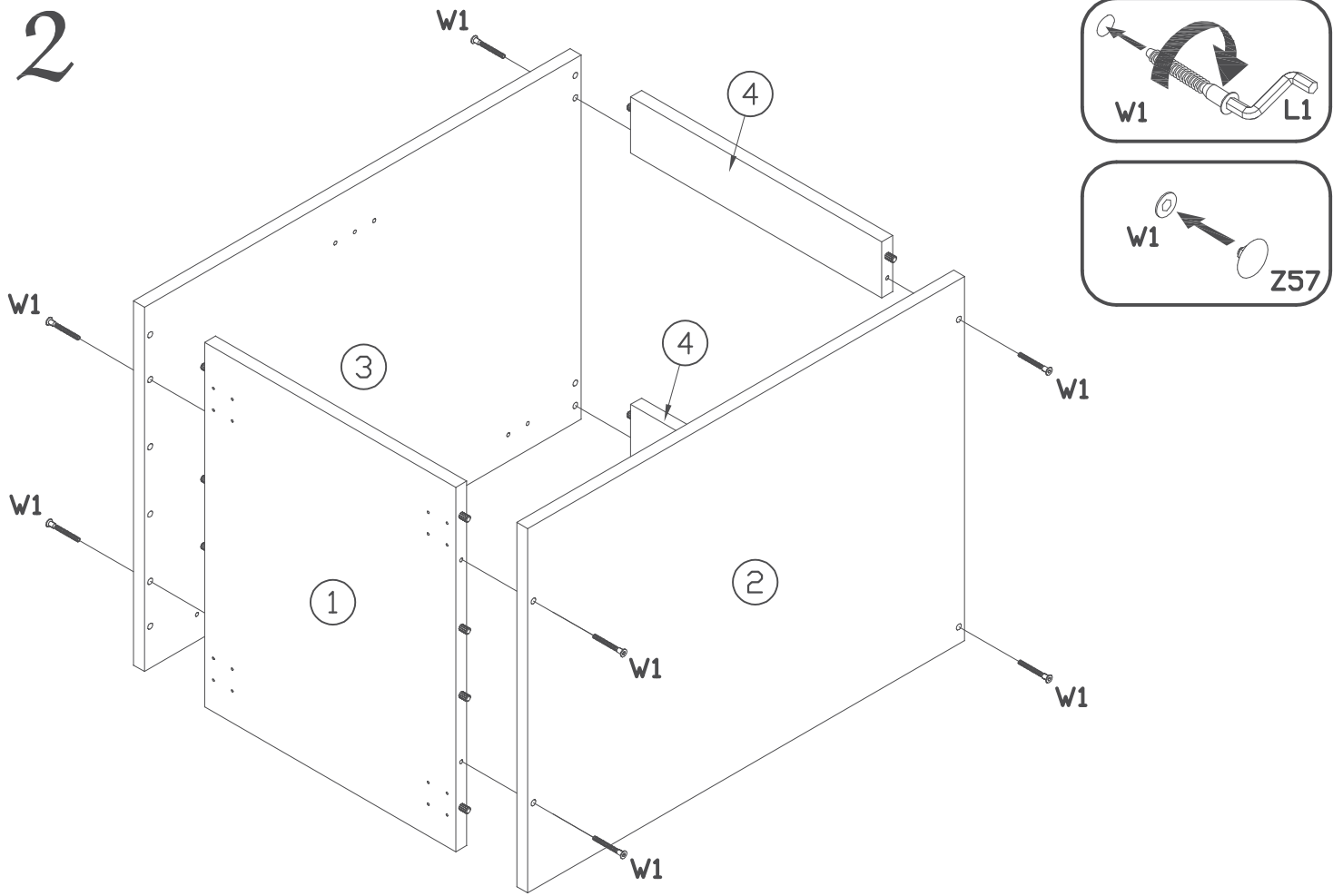

# 3

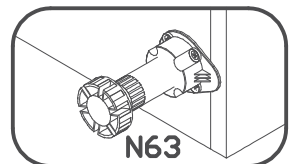
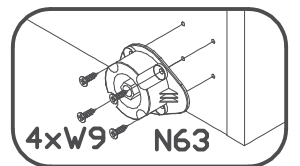
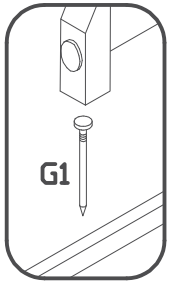
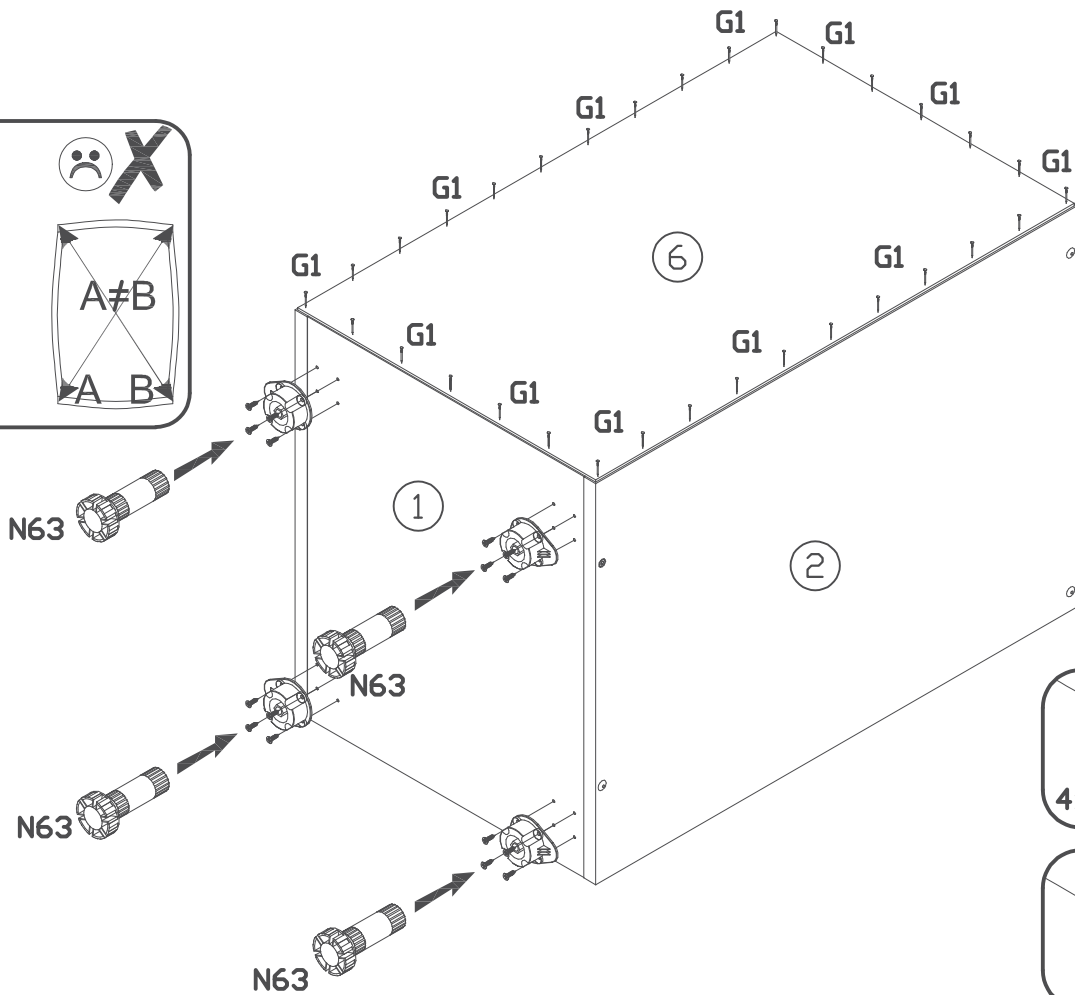
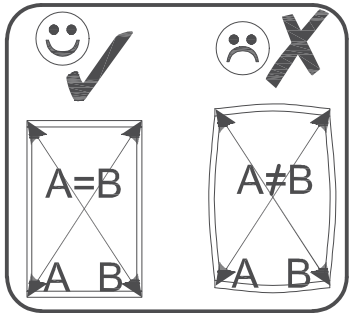

4

