

# INSTRUKCJA MONTAŻU

FITTING-UP INSTRUCTION / AUFBAUANLEITUNG

MONTÁŽNÍ NÁVOD / MONTÁŽNY NÁVOD / SZERELÉSI UTASÍTÁS

**restol**®

Producent:

**Restol sp. z o.o.**

36-055 BRATKOWICE

www.restol.com.pl

# Theo THK-2

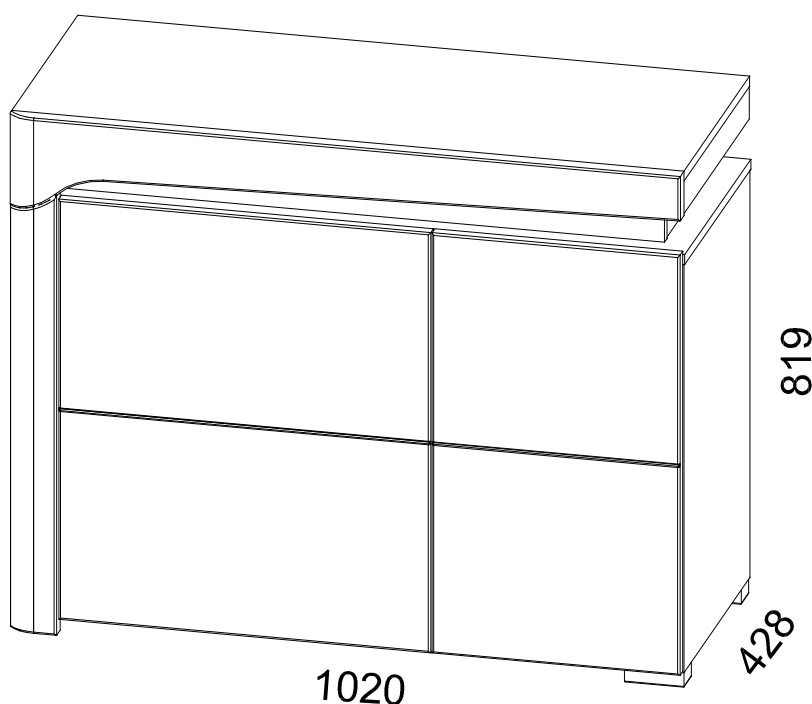

1020 x 819 x 428 /mm/

#### **WSKAZÓWKA na temat pielęgnacji mebla.**

Czyścić elementy wilgotną szmatką lub papierowym ręcznikiem.  
Nie używać chemicznych środków czyszczących.

#### **DIRECTION for the furniture cleaning.**

Clean elements with the moist wiper or soft paper towel. Do not use any detergents.

#### **Pflegehinweis.**

Nur mit feuchtem Lappen, bzw. Papiertuch Ihre Möbel reinigen.  
Keine chemischen Waschmittel einsetzen.

#### **POKYN pro ošetřování nábytku!**

Díly čistit vlhkým hadříkem nebo papírovou utěrkou.  
Nepoužívat chemické čističí prostředky.

#### **POKYNY k údržbě nábytku.**

Prvky nábytku čistit vlhkou handričkou alebo papierovou utierkou  
Nepoužívať chemické čistiace prostriedky.

#### **UTMATATÓ a bútor ápolására.**

Az elemeket nedves ronggyal vagy papírtörülközővel tisztítani.  
Vegyi tisztítószert nem használni.

Gwarancja dostępna pod linkiem:

Guarantee available at:

Die Garantie ist unter dem Link:

Záruka je k dispozici na následujícím odkazu:

Záruka k dispozícii pod odkazom:

Link a jótálláshoz :

[www.sklep.restol.com.pl/  
upload/gwarancja.pdf](http://www.sklep.restol.com.pl/upload/gwarancja.pdf)

# Theo THK-2

NR	WYMIARY	SZT	PACZKA				
2	987 x 400 x 16	1	2 / 3				
6	343 x 115 x 16	2	2 / 3				
7	963 x 115 x 16	1	2 / 3				
8	628 x 400 x 16	1	1 / 3				
9	616 x 375 x 16	1	1 / 3				
10	355 x 375 x 16	1	1 / 3				
11	376 x 656 x 3	1	1 / 3				
12	636 x 656 x 3	1	3 / 3				
13	663 x 376 x 18	1	3 / 3				
14	663 x 564 x 18	1	3 / 3				
15	694,5 x 74 x 25	1	2 / 3				
16	400 x 52 x 16	1	2 / 3				
17	1020 x 147,2 x 25	1	2 / 3				
51	1019 x 400 x 16	1	2 / 3				
53	796 x 400 x 16	1	1 / 3				
54	644 x 400 x 16	1	1 / 3 </tr <tr> <td>55</td> <td>1004 x 400 x 16</td> <td>1</td> <td>2 / 3</td> </tr>	55	1004 x 400 x 16	1	2 / 3
55	1004 x 400 x 16	1	2 / 3				

## INSTRUKCJA MONTAŻU

FITTING-UP INSTRUCTION / AUFBAUANLEITUNG  
MONTÁŽNÍ NÁVOD / MONTÁŽNY NÁVOD / SZERELÉSI UTASÍTÁS

Do montażu potrzebne są:  
You need for fitting-up:  
Zur Montage werden Sie brauchen:  
K montáži jsou potřebné:  
Na montáž potrebujete:  
A szereléshez szükséges:

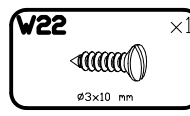
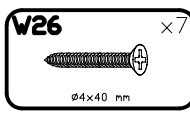
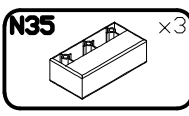
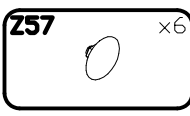
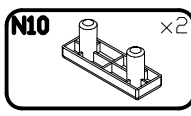
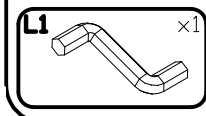
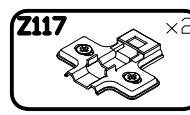
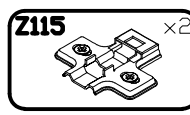
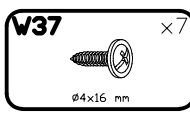
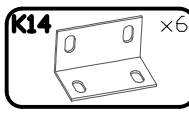
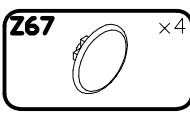
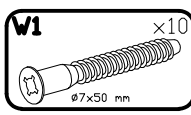
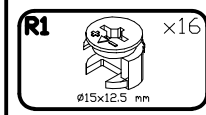
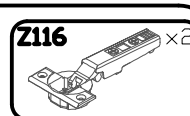
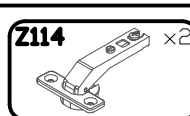
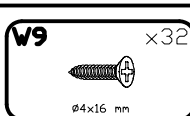
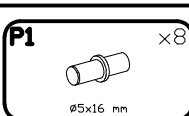
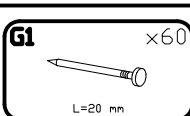
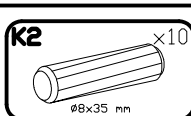
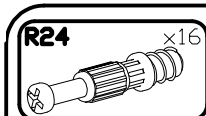
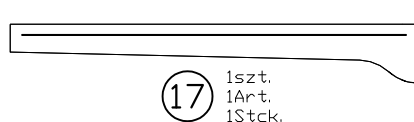
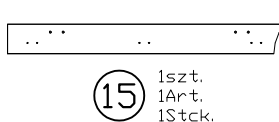
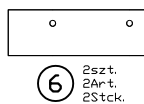
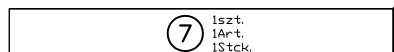
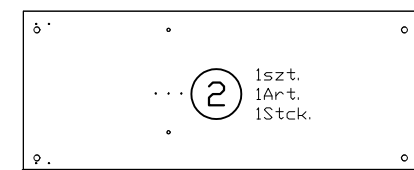
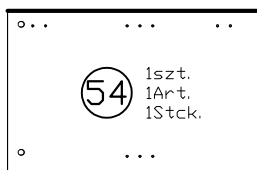
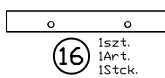
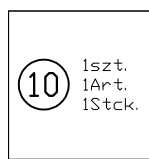
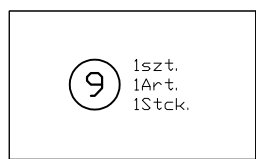
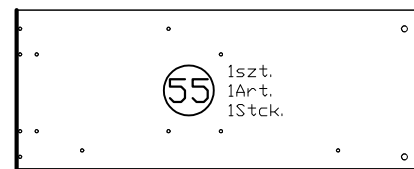
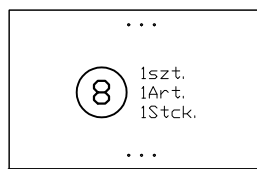
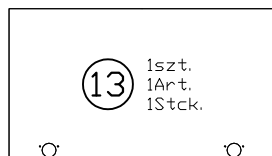
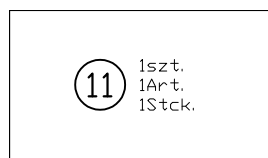
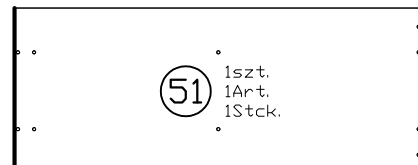
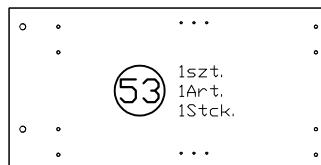
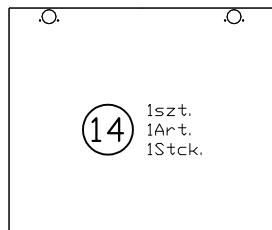
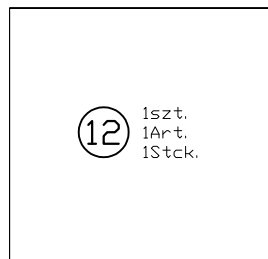
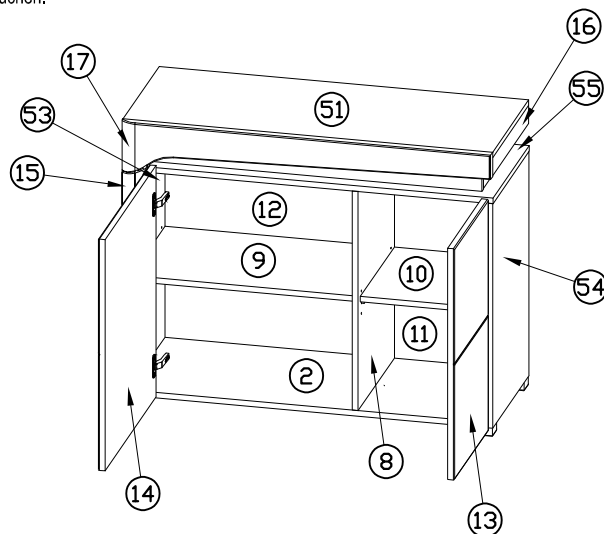
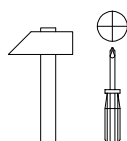
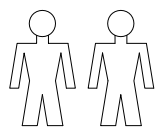

**PODCZAS MONTAŻU POSTĘPOWAĆ ZGODNIE Z INSTRUKCJĄ**

WHILE ASSEMBLING FOLLOW THE INSTRUCTION / MONTAGE LAUT DER AUFBAUANLEITUNG DURCHFÜHREN

PŘI MONTÁŽI POSTUPOVAT PODLE NÁVODU / PRI MONTÁŽI POSTUPOJTE PODĽA NÁVODU / SZERELÉSKOR UTASÍTÁS SZERINT ELJÁRNI

**1** Tfco **THK-2**

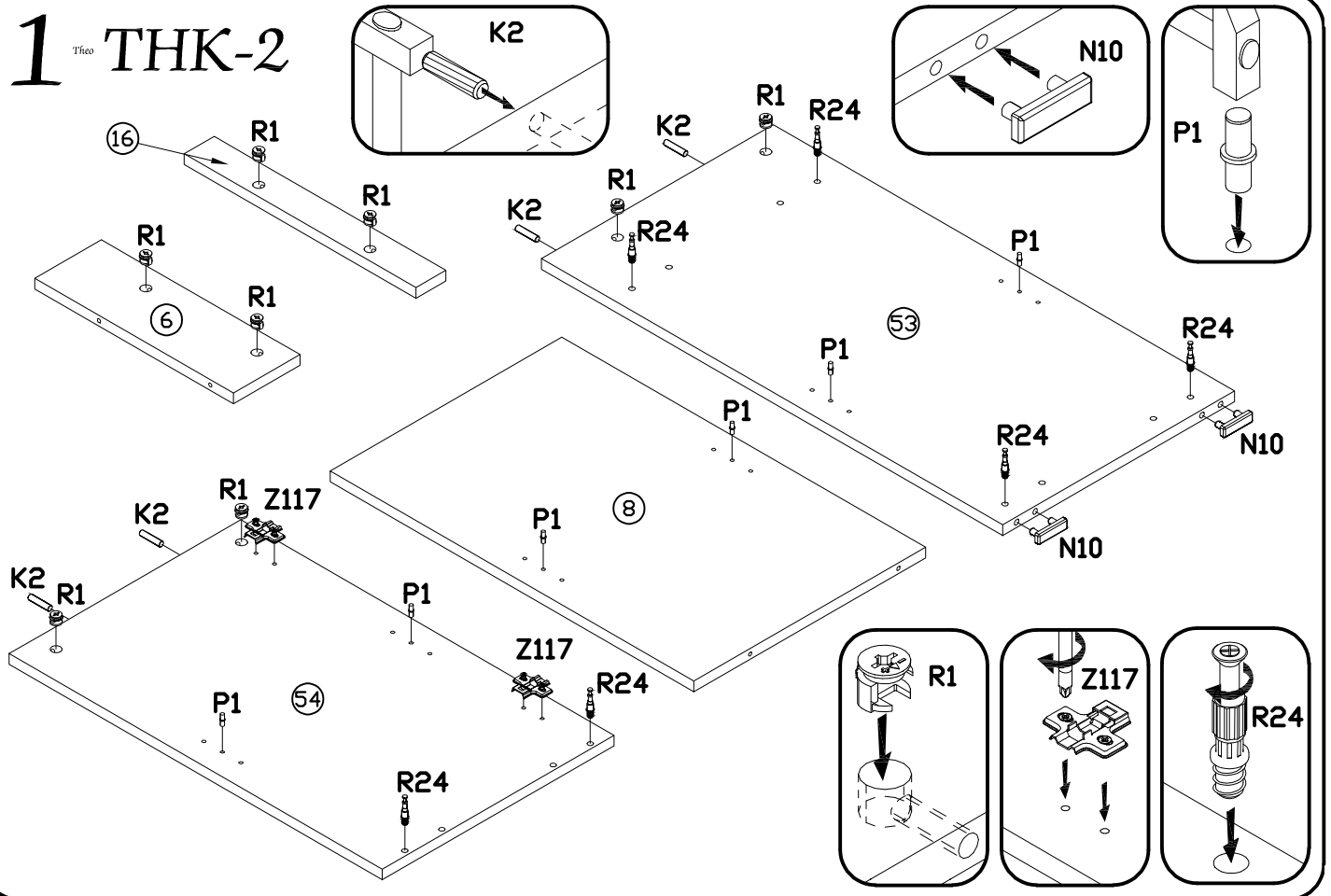

**2** Tfco **THK-2**

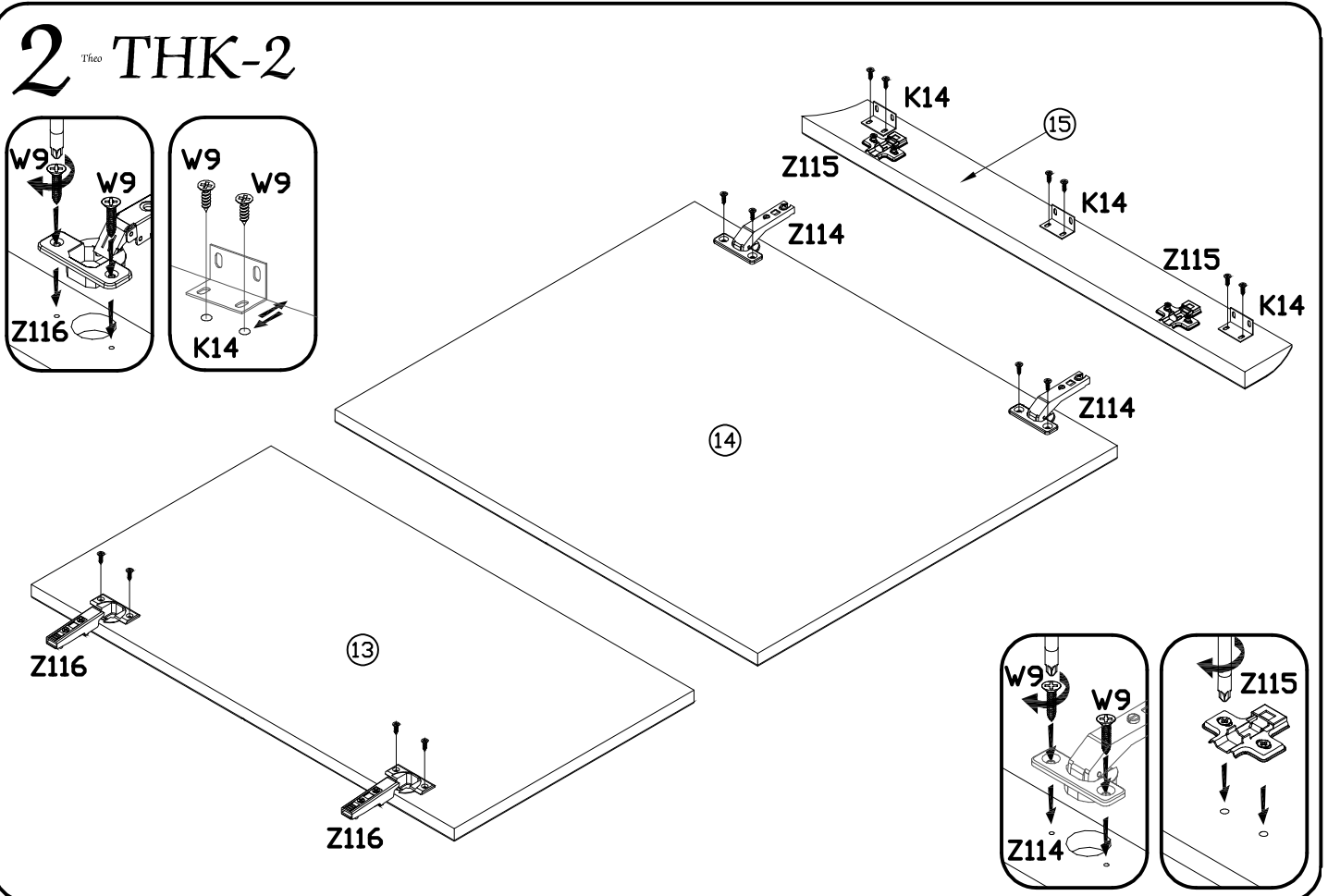

**PODCZAS MONTAŻU POSTĘPOWAĆ ZGODNIE Z INSTRUKCJĄ**

WHILE ASSEMBLING FOLLOW THE INSTRUCTION / MONTAGE LAUT DER AUFBAUANLEITUNG DURCHFÜHREN

PŘI MONTÁŽI POSTUPOVAT PODLE NÁVODU / PRI MONTÁŽI POSTUPOJTE PODĽA NÁVODU / SZERELÉSKOR UTASÍTÁS SZERINT ELJÁRNI

# 3 <sup>Tifco</sup> THK-2

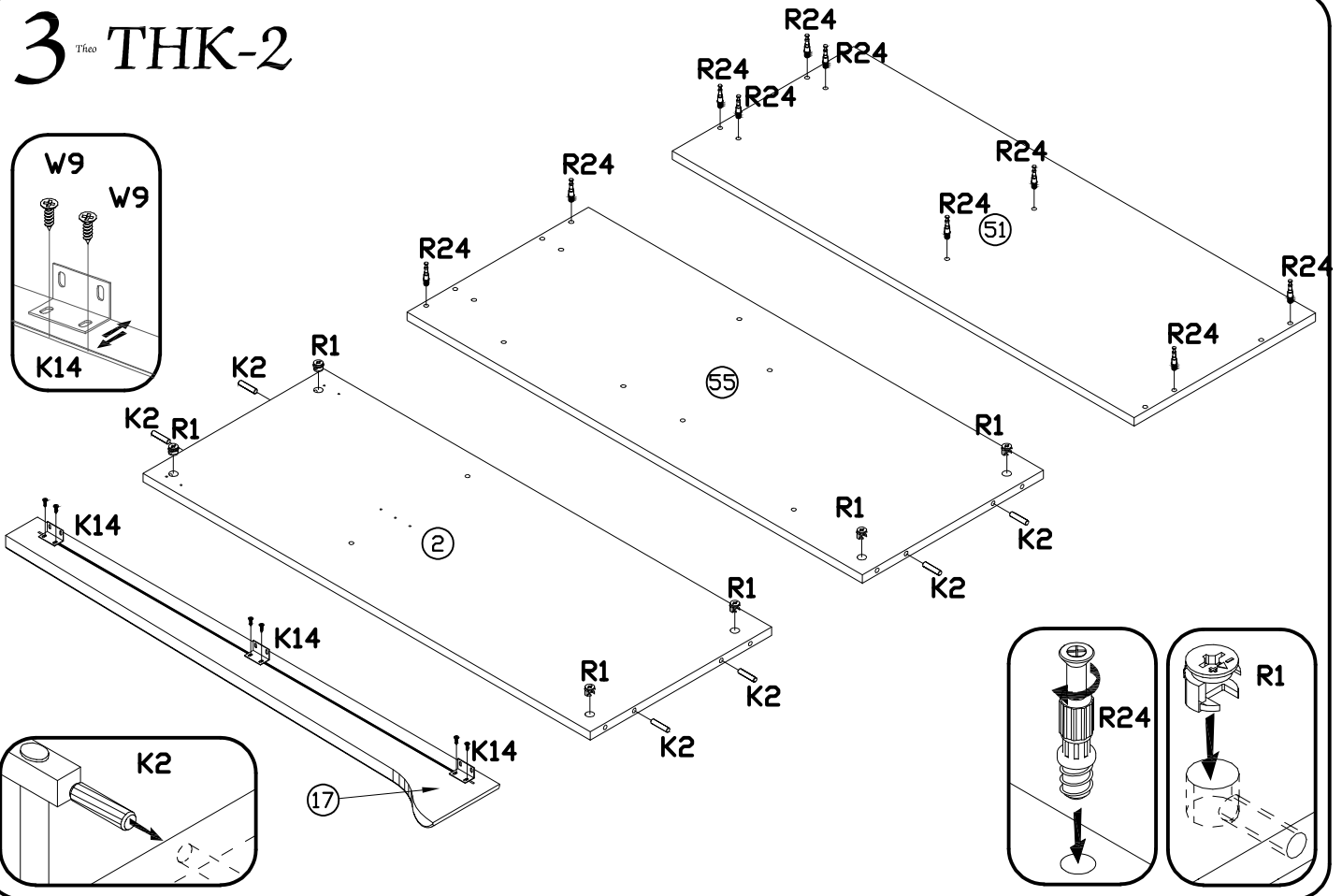

# 4 <sup>Tifco</sup> THK-2

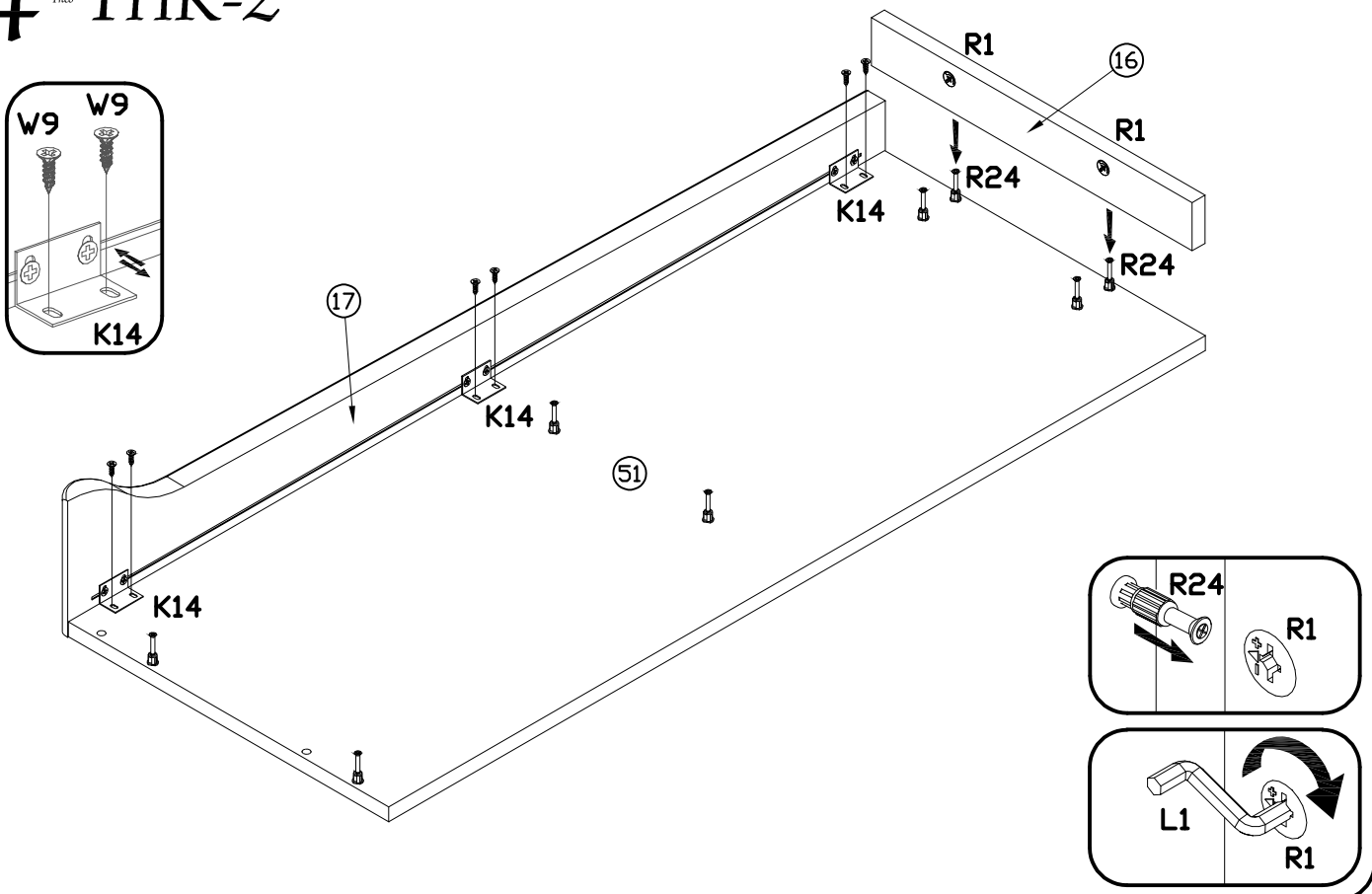

**PODCZAS MONTAŻU POSTĘPOWAĆ ZGODNIE Z INSTRUKCJĄ**

WHILE ASSEMBLING FOLLOW THE INSTRUCTION / MONTAGE LAUT DER AUFBAUANLEITUNG DURCHFÜHREN

PŘI MONTÁŽI POSTUPOVAT PODLE NÁVODU / PRI MONTÁŽI POSTUPUJTE PODĽA NÁVODU / SZERELÉSKOR UTASÍTÁS SZERINT ELJÁRNI

# 5<sup>Tfco</sup> THK-2 - Opcja NEO-8

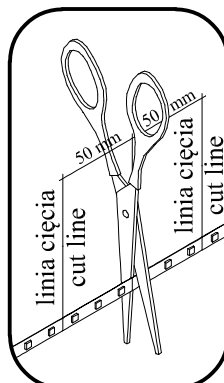
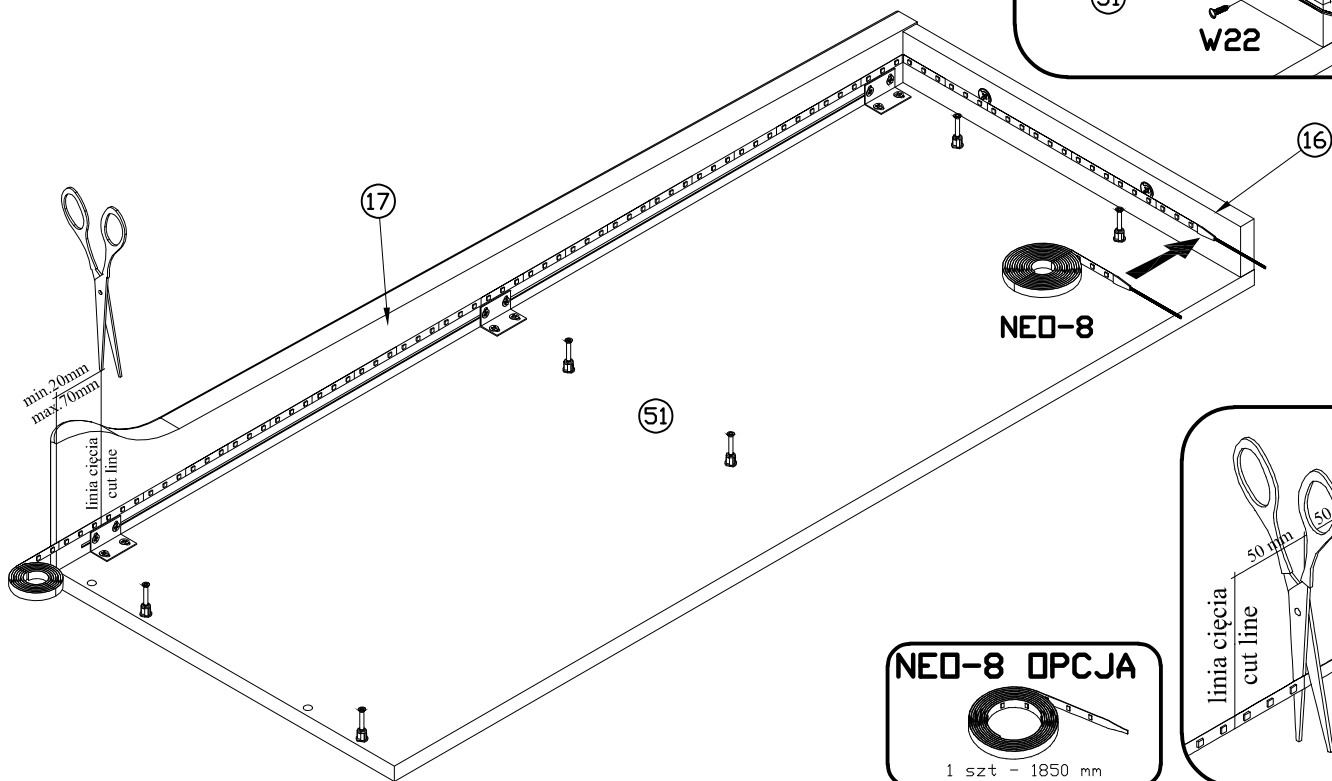
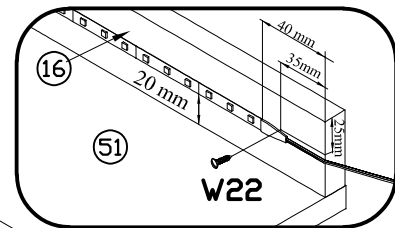

# 6<sup>Tfco</sup> THK-2

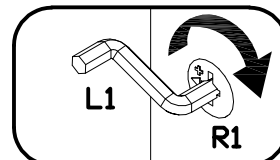
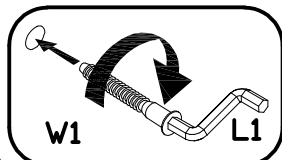
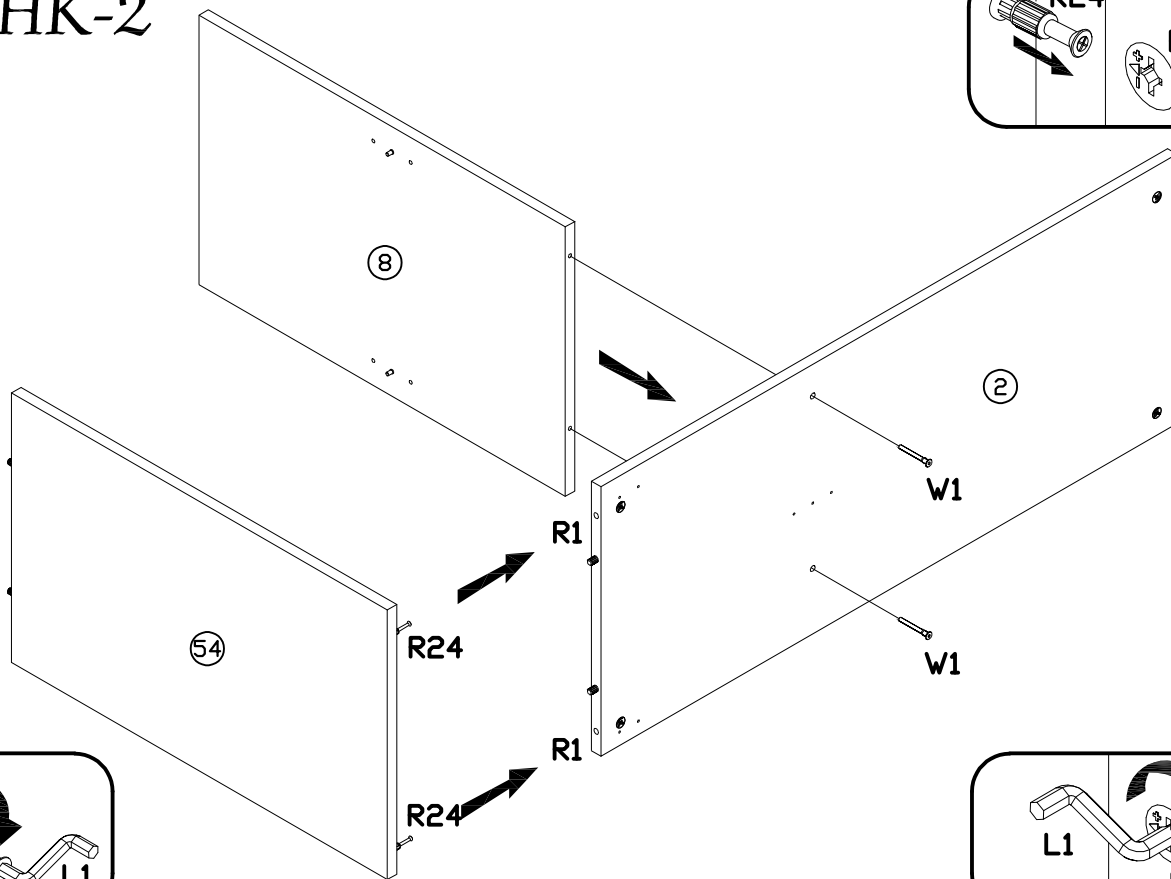
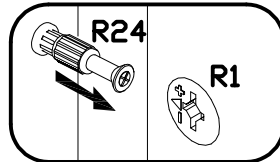

**PODCZAS MONTAŻU POSTĘPOWAĆ ZGODNIE Z INSTRUKCJĄ**

WHILE ASSEMBLING FOLLOW THE INSTRUCTION / MONTAGE LAUT DER AUFBAUANLEITUNG DURCHFÜHREN

PŘI MONTÁŽI POSTUPOVAT PODLE NÁVODU / PRI MONTÁŽI POSTUPOJTE PODĽA NÁVODU / SZERELÉSKOR UTASÍTÁS SZERINT ELJÁRNI

**7** Tfco **THK-2**

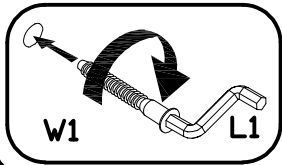
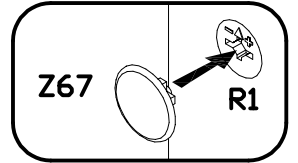
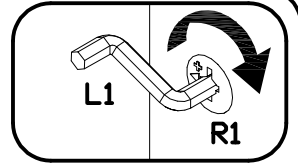
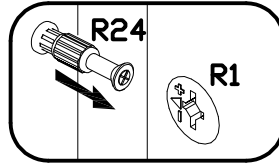
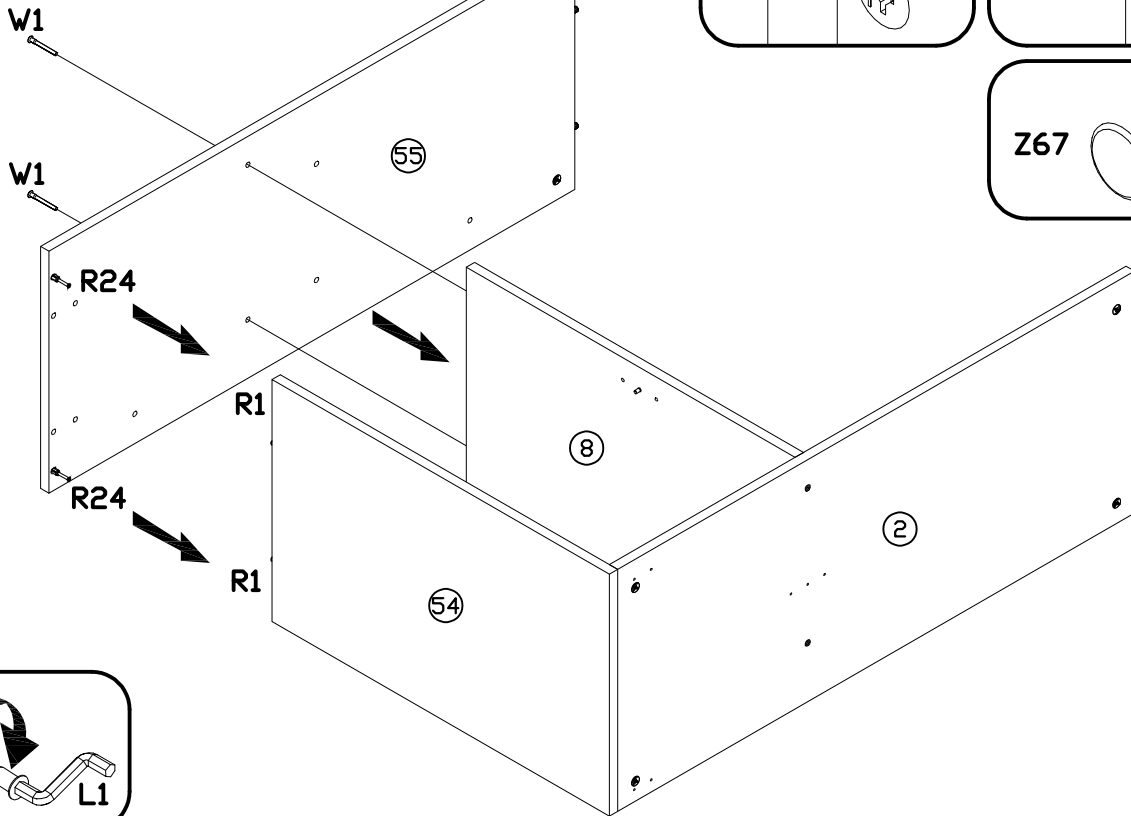

**8** Tfco **THK-2**

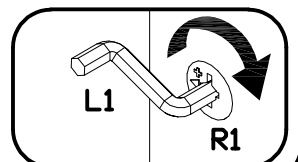
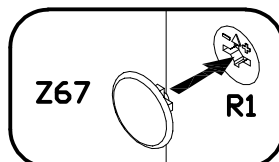
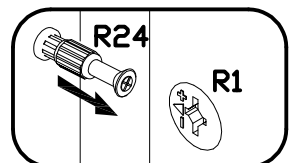
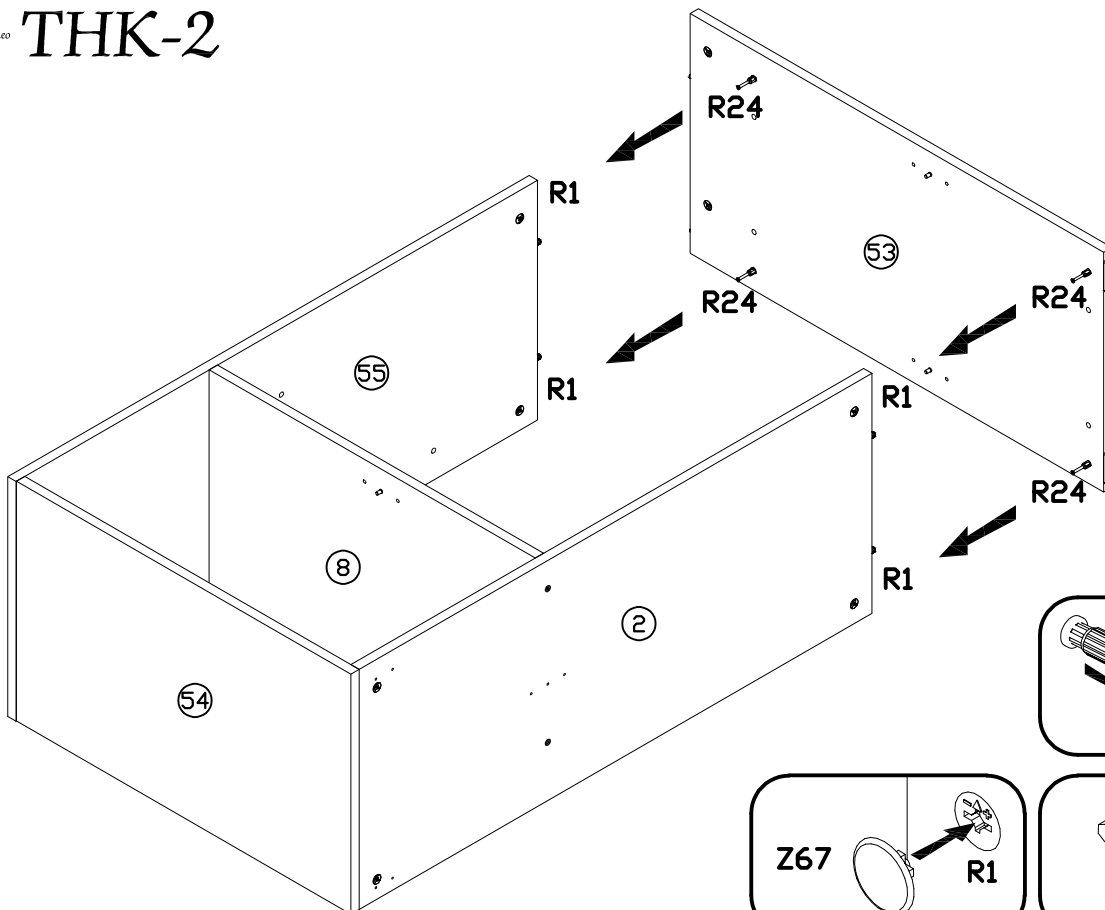

**PODCZAS MONTAŻU POSTĘPOWAĆ ZGODNIE Z INSTRUKCJĄ**

WHILE ASSEMBLING FOLLOW THE INSTRUCTION / MONTAGE LAUT DER AUFBAUANLEITUNG DURCHFÜHREN

PŘI MONTÁŽI POSTUPOVAT PODLE NÁVODU / PRI MONTÁŽI POSTUPUJTE PODĽA NÁVODU / SZERELÉSKOR UTASÍTÁS SZERINT ELJÁRNI

# 9<sup>THK-2</sup>

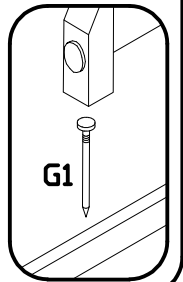
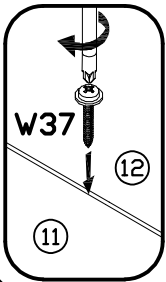
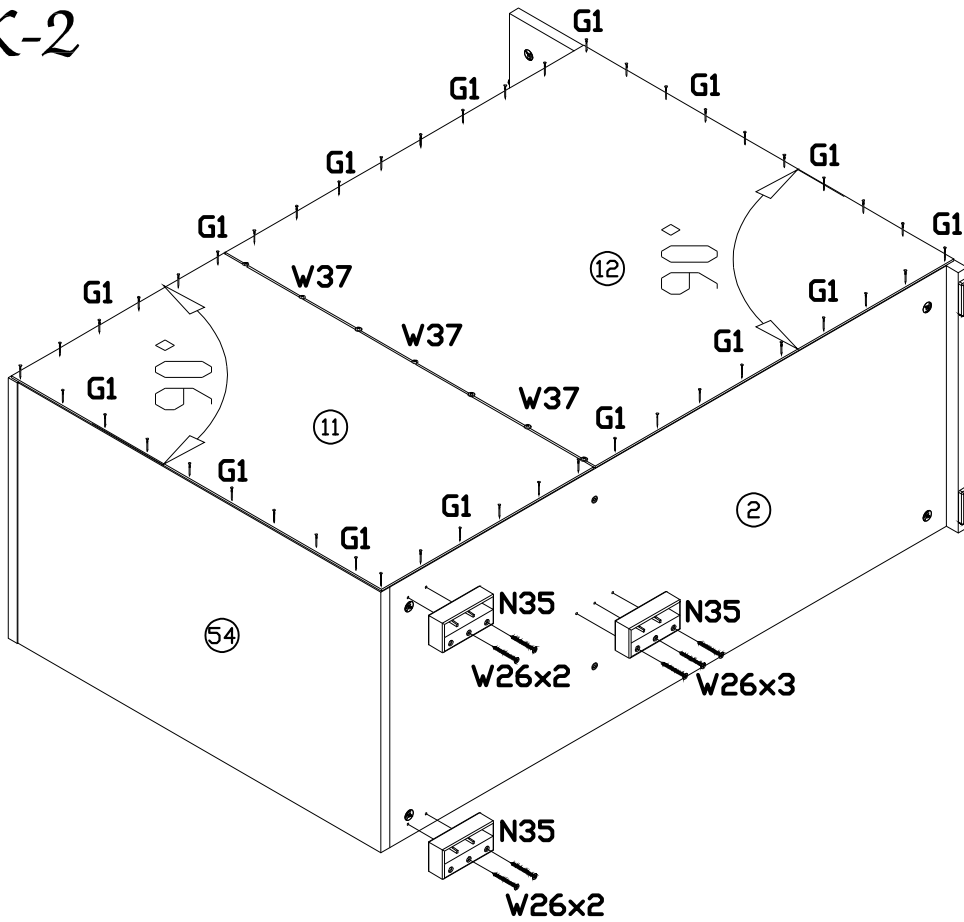

# 10<sup>THK-2</sup>

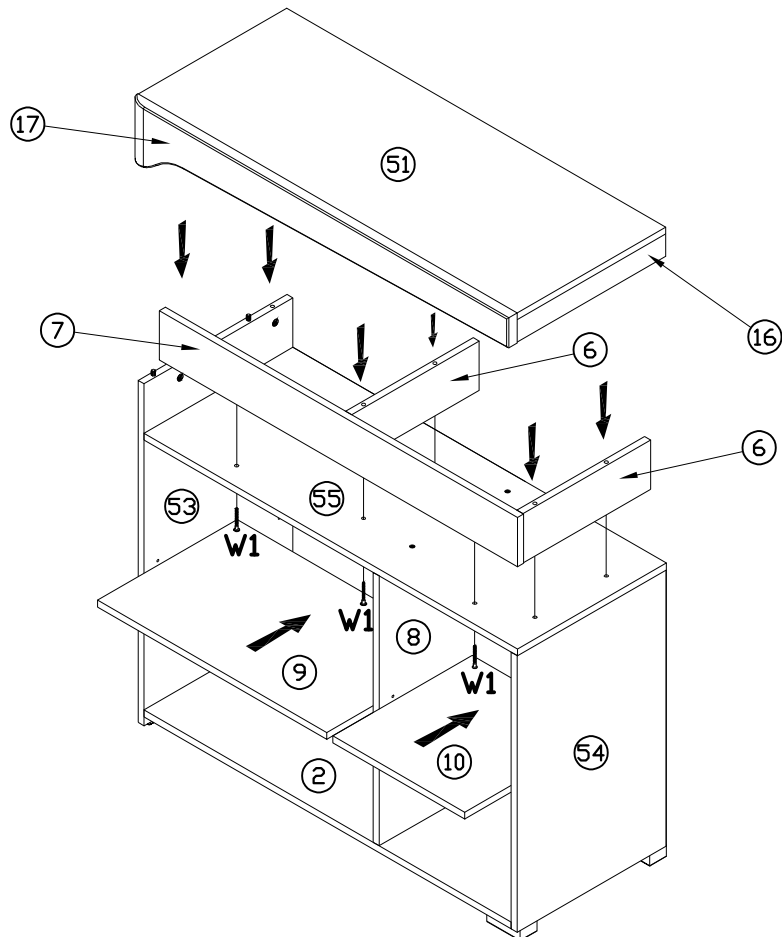
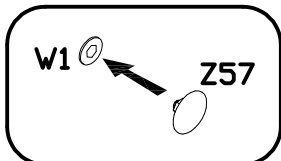
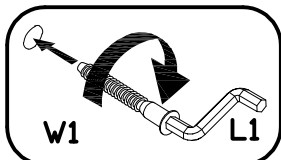
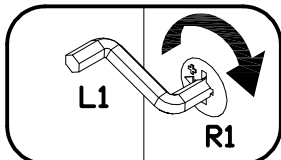
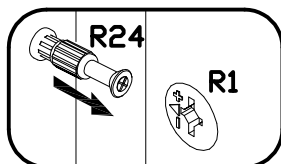

**PODCZAS MONTAŻU POSTĘPOWAĆ ZGODNIE Z INSTRUKCJĄ**

WHILE ASSEMBLING FOLLOW THE INSTRUCTION / MONTAGE LAUT DER AUFBAUANLEITUNG DURCHFÜHREN

PŘI MONTÁŽI POSTUPOVAT PODLE NÁVODU / PRI MONTÁŽI POSTUPUJTE PODĽA NÁVODU / SZERELÉSKOR UTASÍTÁS SZERINT ELJÁRNI

# 11 <sup>THK-2</sup>

